

BLICKMAN



Ambulatory Surgery Centers (ASC)

Quick, mobile, sterile environment

Includes:

- Cabinets and Casework
- Case Carts
- Chairs
- Exam Stools
- Foot Stools
- Hampers
- IV Stands
- Mayo Stands
- Scrub Sinks
- Solution Stands
- Surgical Utensils
- Tables
- Utility Carts
- Warming Cabinets

BLICKMAN



Cabinets & Casework

Customizable, secure, and organized

Includes:

- Freestanding Cabinets
- Customizable Casework
- Sinks and Countertops
- Console Cabinets
- Accessories and Options



THE BLICKMAN DIFFERENCE

Freestanding Cabinets

- Our stainless steel cabinets are constructed with a seamless welded face preventing dirt collection while providing long lasting durability through unparalleled strength and corrosion resistance.
- Our freestanding cabinets rest on four legs with glides or can be mobilized on casters.
- Add a sloped top to prevent dirt collection to create a sterile environment.
- Kay and Kennedy cabinets feature two separate sections with unlocked or locked compartments.
- Paul and Walter cabinets provide maximum storage room for large equipment.

Key Product Features

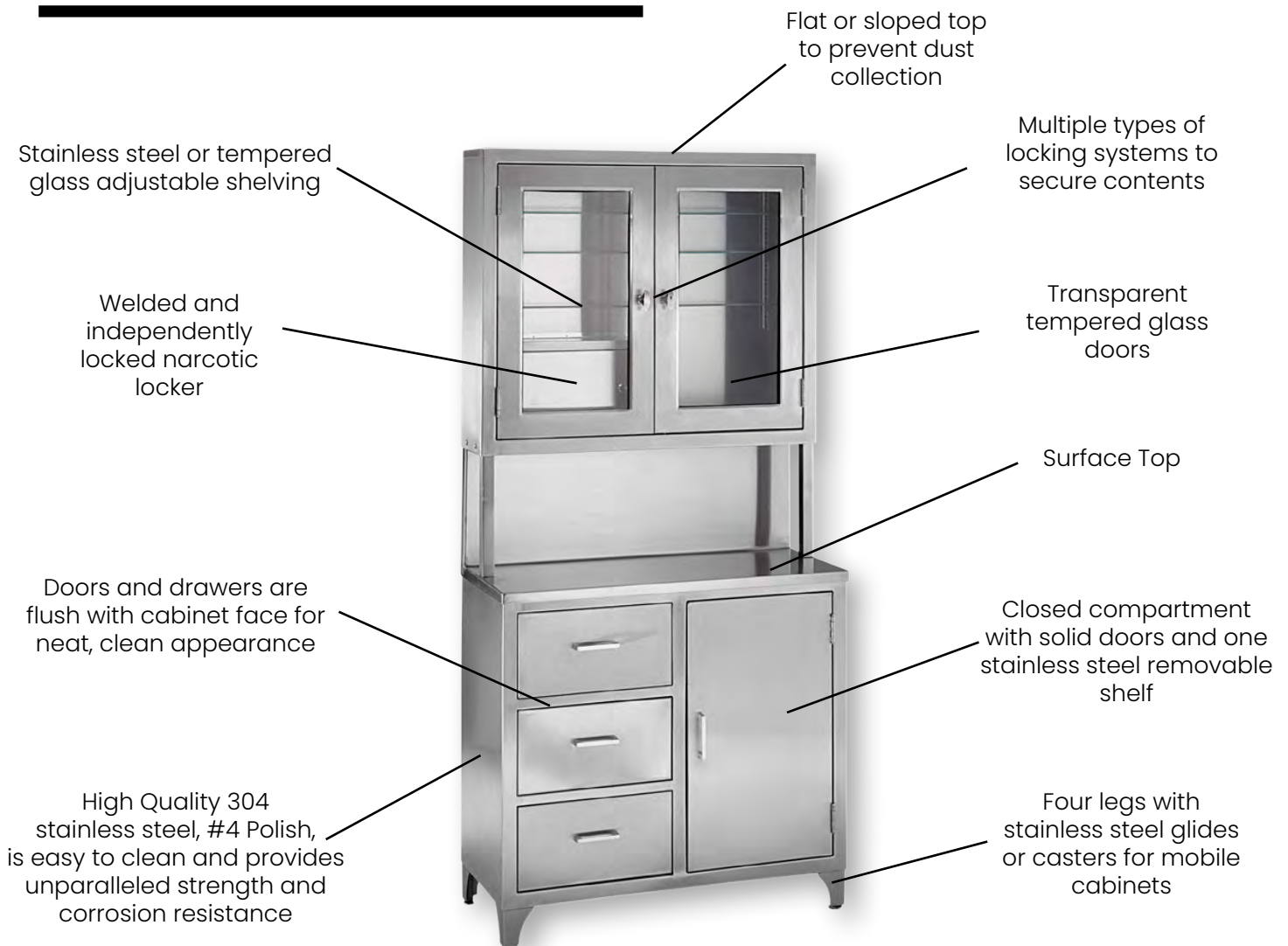

Cabinets

Freestanding

FREESTANDING

Description: Our Kay and Kennedy freestanding cabinets feature separate upper and lower sections. The upper sections of these cabinets are locked, transparent compartments for easily viewing and securing contents. The Kennedy cabinet includes an independently locked and welded narcotic locker.



Kay Cabinet

Upper section: Consists of a locked 29 3/4" x 31 3/8" x 15" compartment with a glass door and three removable glass shelves

Lower section: Consists of a 29 3/4" x 20 1/2" x 15" compartment with a stainless steel door and one stainless steel shelf



Kennedy Cabinet

Upper Section: 8" deep and contains a welded and independently locked narcotic locker

Lower Section: 16" deep and contains three 7" deep drawers and one 15" deep compartment

| Name | Kay | Kennedy |
|---------------------------|------------------------|----------------------------|
| Dimensions (WxHxD) | 30" x 58" x 16" | 36" x 76 1/2" x 16" |
| Model # | 7953SS | 7956SS |
| Item # | 1517953000 | 1527956000 |
| Shipping Weight | 219 lbs. | 291 lbs. |

Options: 2 "Casters, stainless steel shelves for upper cabinets, sloping top, all stainless steel doors

Custom Designs Available Upon Request
Please email us at info@blickman.com

Cabinets

Freestanding

FREESTANDING

Description: Our Paul and Walter cabinets are double door freestanding cabinets. They each come standard with two glass locked doors for securing contents. Our Walter cabinet is ideal for storing large instruments on its back pegboard, while our Paul cabinet includes shelving for storing lots of instruments and supplies. They are both 16" deep and 76" tall on gliders. They are 79 1/4" tall on casters. Choose from two standard width sizes: 35 5/8" and 47 5/8".



Walter Cabinet

This cabinet is great for storing endoscopy equipment or other large instruments on its pegboard



Paul Cabinet

This cabinet provides maximum shelving storage for instruments and supplies. Glass shelves are adjustable every 1/2"

| Name | Walter | | Paul | |
|-----------------|------------|------------|------------|------------|
| | 35 5/8"W | 47 5/8"W | 35 5/8"W | 47 5/8"W |
| Model # | 7959SS | 7960SS | 7970SS | 7971SS |
| Item # | 1537959000 | 1537960000 | 1537970000 | 1537971000 |
| Shipping Weight | 269 lbs. | 310 lbs. | 330 lbs. | 400 lbs. |

Options: Glides or casters, recessing, flat top, stainless steel shelves (Paul Cabinet), all stainless steel doors

Custom Designs Available Upon Request
Please email us at info@blickman.com

Cabinets

FREESTANDING
Options &
Accessories

FOOT OPTIONS



Locking Casters



Casters



Gliders

ACCESSORIES



Electronic Locking Systems,
available for most of our cabinets



Additional Shelves, your choice of
stainless steel or glass



Sloped top (see order details
below)

| Model # | Item # | Description | Shipping Weight |
|---------|------------|--|-----------------|
| ST-3016 | 4503516300 | Sloped Top for Kay (30" x 6" x 16") | 35 lbs. |
| ST-3608 | 4503536080 | Sloped Top for Kennedy (36" x 6" x 8") | 37 lbs. |
| ST-3516 | 4503516350 | Sloped Top for Walter or Paul (slim) (35 5/8" x 6" x 16") | 43 lbs. |
| ST-4716 | 4503516470 | Sloped Top for Walter or Paul (wide) (47 5/8" x 6" x 16") | 54 lbs. |

Cabinets

FREESTANDING
Construction
Specifications

Construction Specifications

| | |
|---------------------|--|
| Standard Dimensions | All Freestanding Cabinets: 16" deep |
| Materials | 304 stainless steel 1/4" clear tempered sheet glass |
| Gauge | Body, Sloped Top, Drawers, and Shelf Inserts: 18GA; Legs: 12GA Glass Doors (Front and Back): 18GA Solid Doors (Front): 18GA; Solid Doors (Back): 20GA |
| Welding | All welding by heliarc method and exposed welds are ground smooth |
| Finish | Exposed surfaces are free from pit marks, weld seams, scale and are polished with #4 polish to a satin finish |
| Casters | 2" or 3" ball bearing, swivel casters with brakes |
| Notes | <ul style="list-style-type: none">• Kay: A counter weight is fastened underneath at bottom rear of cabinet for doors in open position. Upper door fitted with lock handle and three way latching device engaging at top.• Kennedy: Right hand door equipped with a locking knob and three way latching. Left hand door with dummy knob and roller latch. An independently locked narcotic cabinet, 13 1/4" x 5" x 7 3/4" with double walled door is welded to the bottom, back, and side of the compartment.• Paul & Walter: A counter weight is fastened underneath at bottom rear of cabinet for doors in open position. Right hand door is fitted with a locking handle and three point latching, and the left door has a dummy knob and spring loaded nylon roller catches. |

Shipping Information

All shipping weights are estimates and may be changed without prior notice. Specifications may be improved and dimensions changed without prior notice. Please contact customer service for estimated shipping costs at info@blickman.com.

THE BLICKMAN DIFFERENCE

Casework

- Need more flexibility in today's space squeezed environment? We provide you with casework that can be assembled together and modified to fit your custom dimensions.
- Whether it is renovation or new construction, we will be happy to work with your facility's personnel, architects, contractors, and/or equipment planners to meet your custom requirements.
- Utilizing 3D Design Software REVIT®, we have developed a library of our standard products which is available at no charge to your company. Our 3D library will save you considerable time and money when working on projects that require stainless steel cabinets and equipment.
- Each product line of cabinets (console cabinets, high cabinets, base cabinets, and wall cabinets) have their individual properties identified for easy customization: (cubic feet, weight, "X", "Y" and "Z" dimensions, voltage, etc.).

Key Product Features

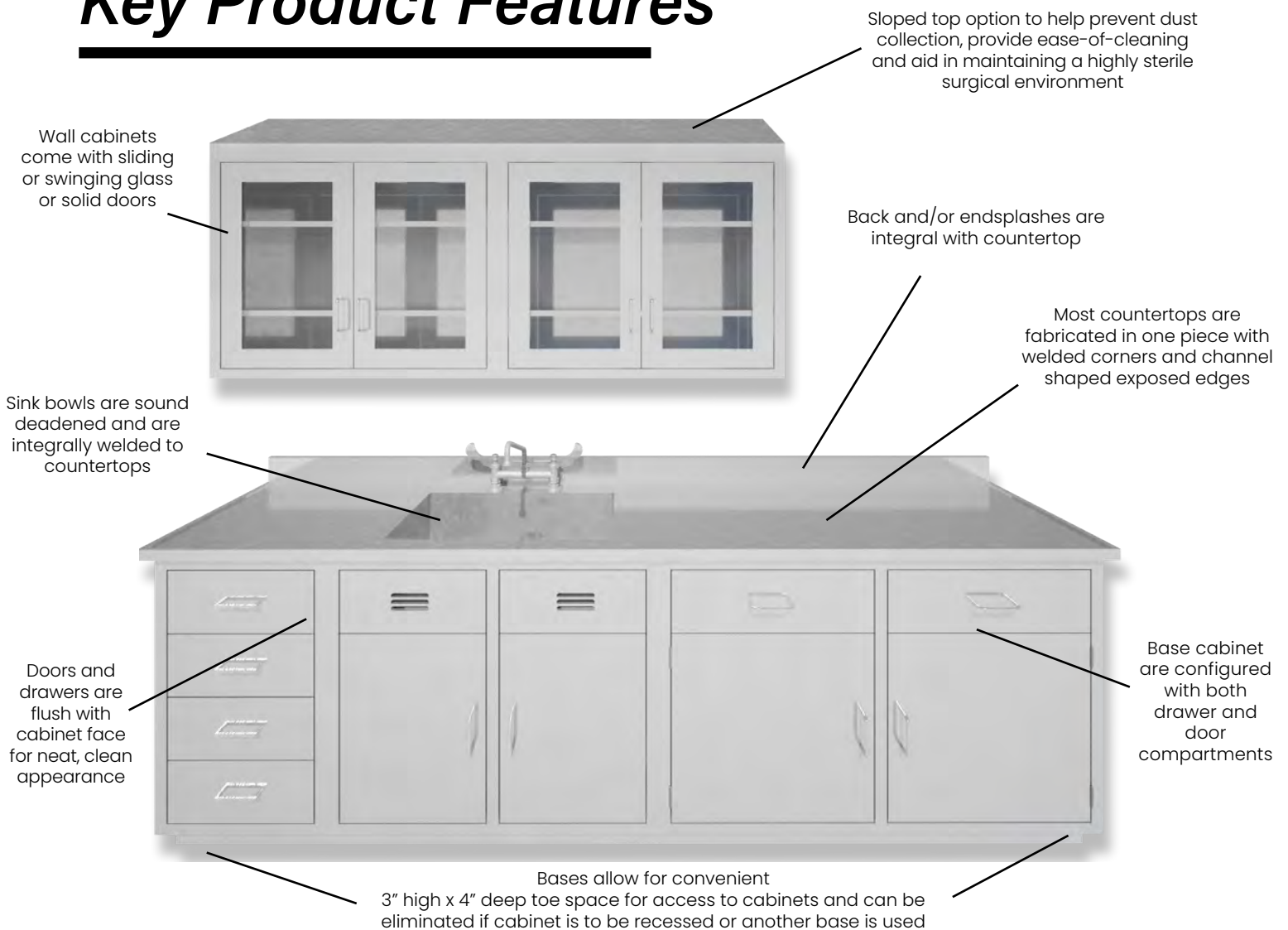

www.blickman.com

Cabinets

Customizable
Casework

HIGH CABINETS

Description: Our stainless steel high cabinets are designed to stand alone or fit within a framework of cabinets. They are constructed as floor and wall supported individual cases with finished sides. They each contain five adjustable stainless steel shelves, with the option of glass shelves and additional shelves. They are all 84" tall and 18" deep cabinets. Width varies and other alternative dimensions are available.

Customize the widths and depths of these models to your room.

Common Dimensions:

Single Door: 21 3/4" and 24 3/4" W

Double Door: 29", 41", and 47"W

Alternative Depth: 23"D

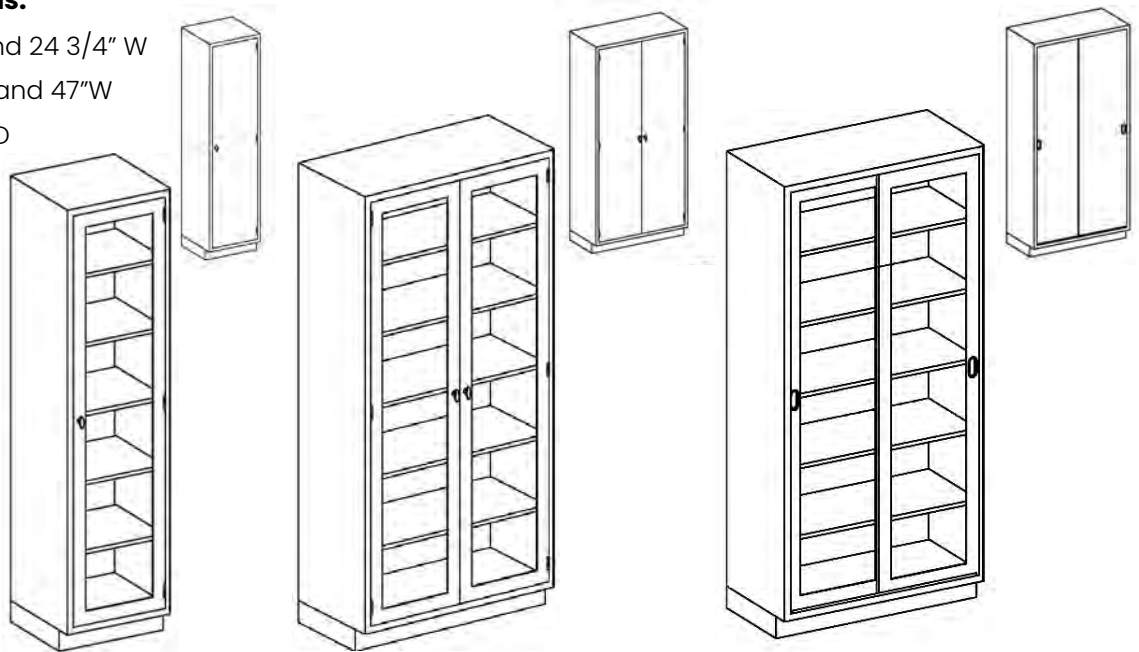

| Name | Single Door | Double Door | Double Sliding Doors |
|--------------------|---------------------|------------------------------------|----------------------|
| | | Glass Doors | |
| Dimensions (WxHxD) | 18 3/4" x 84" x 18" | 35" x 84" x 18" | 35" x 84" x 18" |
| Model # | K18HAS | L35HAS | M35HAS |
| Item # | 2030518000 | 203053500 | 2030635000 |
| Shipping Weight | 215 lbs. | 310 lbs. | 325 lbs. |
| | | Solid Stainless Steel Doors | |
| Dimensions (WxHxD) | 18 3/4" x 84" x 18" | 35" x 84" x 18" | 35" x 84" x 18" |
| Model # | H18HAS | I35HAS | J35HAS |
| Item # | 2030418000 | 2030435000 | 2030535180 |
| Shipping Weight | 230 lbs. | 300 lbs. | 347 lbs. |

Options: Sloped top, glass shelves, additional shelves

Custom Designs Available Upon Request
Please email us at info@blickman.com

Cabinets

Customizable
Casework

WALL CABINETS

Description: Our stainless steel wall cabinets are designed to stand alone with finished sides or to fit within a framework of cabinets. They are constructed for flush face wall surfaces with a recessed back panel for uneven wall surfaces. Each cabinet comes with two 1/2" adjustable stainless steel shelves. Choose from swinging or sliding doors made of either solid stainless steel or glass. Our wall cabinets are all 30" tall and 13" deep. Width varies and other alternative dimensions are available.

Customize the widths and heights of these models to your room.

Common Dimensions:

Single Door: 18 3/4", 21 3/4", and 24 3/4" W

Double Door: 29", 35" 41", and 47"W

Alternative Heights: 36" and 48"H

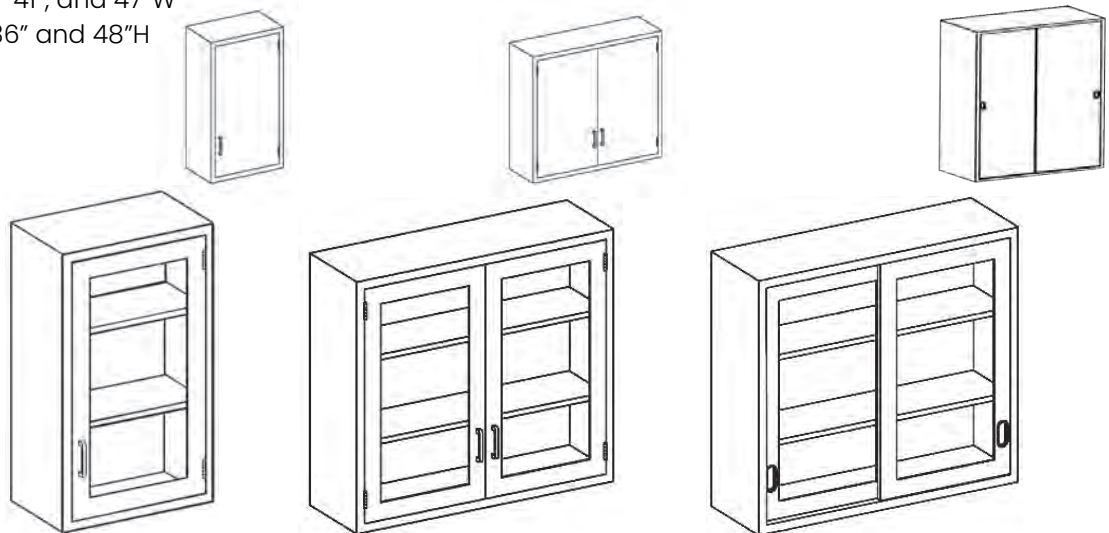

| Name | Single Door | Double Door | Sliding Doors |
|--------------------|---------------------|------------------------------------|-----------------|
| | | Glass Doors | |
| Dimensions (WxHxD) | 18 3/4" x 30" x 13" | 35" x 30" x 13" | 35" x 30" x 13" |
| Model # | D18LS | E35LS | F35LS |
| Item # | 2020318000 | 2020335000 | 2023035000 |
| Shipping Weight | 95 lbs. | 145 lbs. | 135 lbs. |
| | | Solid Stainless Steel Doors | |
| Dimensions (WxHxD) | 18 3/4" x 30" x 13" | 35" x 30" x 13" | 35" x 30" x 13" |
| Model # | A18LS | B35LS | C35LS |
| Item # | 2020218000 | 2020235000 | 2023135000 |
| Shipping Weight | 90 lbs. | 141 lbs. | 130 lbs. |

Options: Sloped top, glass shelves, additional shelves

Custom Designs Available Upon Request

Please email us at info@blickman.com

Cabinets

Customizable
Casework

OPEN WALL SHELVES

Description: Our stainless steel open wall cabinet is designed to stand alone with finished sides or fit within a framework of cabinets and comes with two adjustable stainless steel shelves. Alternatively, we offer a wall shelf that can be placed anywhere along a wall.

Common Dimensions:

Wall Cabinet Widths: All Single and Double Width Sizes
Heights: 36" and 48"

Wall Shelf Widths: 48", 60", and 72", Depths: 16"

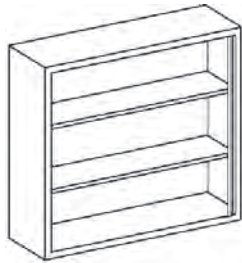

| Name | Open Wall Cabinet | | Wall Shelf | |
|--------------------|-------------------|-----------------|------------|------------|
| Width | 35" W | 47" W | 36" W | 84" W |
| Dimensions (WxHxD) | 35" x 30" x 13" | 47" x 30" x 13" | 36" x 12" | 84" x 12" |
| Model # | G35LS | G47LS | WS3612 | WS8412 |
| Item # | 2020435000 | 202044700 | 1813612000 | 1818412000 |
| Shipping Weight | 75 lbs. | 142 lbs. | 26 lbs. | 40 lbs. |

OPEN BASE CABINETS

Description: Our stainless steel open base cabinets offer open shelving to fit within a framework of cabinets or stand alone with finished sides. They are constructed for flush face wall surfaces and come with two adjustable stainless steel shelves. Our open base cabinets are all 22" deep and 35 3/4" high and come in a variety of width sizes.

Other Commonly Ordered Single Width Sizes: 21 1/8" W

Other Commonly Ordered Double Width Sizes: 29"W and 41"W

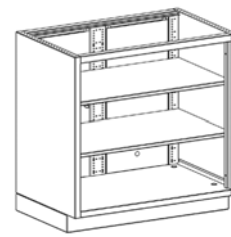

| Name | Single Width | | Double Width | |
|-----------------|--------------|------------|--------------|------------|
| Width | 18 1/8" W | 24 1/8" W | 35" W | 47" W |
| Model # | AJ18HS | AJ24HS | AJ35HS | AJ47HS |
| Item # | 2012518000 | 2012524000 | 2012535000 | 2012547000 |
| Shipping Weight | 102 lbs. | 122 lbs. | 152 lbs. | 170 lbs. |

Custom Designs Available Upon Request

Please email us at info@blickman.com

Cabinets

Customizable
Casework

SINGLE BASE CABINETS

Description: Our stainless steel single width base cabinets come in five different configurations and are designed to stand alone with finished sides or to fit within a framework of cabinets. They are all 35 3/4" tall and 22" deep, and come in two width sizes, 18 1/8" and 24 1/8". **Other Commonly Ordered Single Width Sizes:** 21-1/8"W



**-AA-
Door**

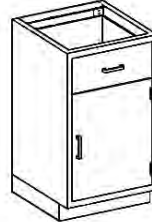

**-AB-
Door, Drawer**

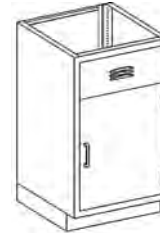

**-AC-
Door, Vent (Sink)**

| Name | 18 1/8" Wide | | |
|-----------------|---------------------|------------|------------|
| Model # | AA18HS | AB18HS | AC18HS |
| Item # | 2012118000 | 2012218000 | 2012218001 |
| Shipping Weight | 80 lbs. | 125 lbs. | 107 lbs. |
| Name | 24 1/8" Wide | | |
| Model # | AA24HS | AB24HS | AC24HS |
| Item # | 2012224000 | 2012124000 | 2012224001 |
| Shipping Weight | 132 lbs. | 147 lbs. | 118 lbs. |

Note: Cabinets without vents include one stainless steel shelf inside



**-AS-
3 Drawer**



**-AE-
4 Drawer**

| Name | 18 1/8" Wide | |
|-----------------|---------------------|------------|
| Model # | AS18HS | AE18HS |
| Item # | 2012718000 | 2012318000 |
| Shipping Weight | 167 lbs. | 174 lbs. |
| Name | 24 1/8" Wide | |
| Model # | AS24HS | AE24HS |
| Item # | 2012724000 | 2012324000 |
| Shipping Weight | 183 lbs. | 192 lbs. |

Note: Cabinets without vents include one stainless steel shelf inside

Custom Designs Available Upon Request

Please email us at info@blickman.com

Cabinets

Customizable
Casework

DOUBLE BASE COMPARTMENT CABINETS

Description: Our stainless steel double base compartment cabinets come in seven different configurations and are designed to stand alone with finished sides or to fit within a framework of cabinets. They are all 35 3/4" tall and 22" deep, and come in two width sizes, 35" and 47". **Other Commonly Ordered Sizes:** 29"W and 41"W



Name

**-DA-
Double Door**

**-DB-
Double Vent (Sink)**

**-DC-
Large Drawer**

**-DD-
Double Drawer**

35" Wide

| | | | | |
|-----------------|------------|------------|------------|------------|
| Model # | DA35HS | DB35HS | DC35HS | DD35HS |
| Item # | 2013235200 | 2013235000 | 2013235001 | 2013335000 |
| Shipping Weight | 161 lbs. | 145 lbs. | 200 lbs. | 194 lbs. |

47" Wide

| | | | | |
|-----------------|------------|------------|------------|------------|
| Model # | DA47HS | DB47HS | DC47HS | DD47HS |
| Item # | 2013247200 | 2013247000 | 2013247001 | 2013347000 |
| Shipping Weight | 205 lbs. | 178 lbs. | 235 lbs. | 243 lbs. |

Note: Cabinets without vents include one stainless steel shelf inside



Name

**-DG-
1 Door, 4 Drawer**

**-DJ-
1 Door, 8 Drawer**

**-DK-
1 Door, 5 Drawer**

35" Wide

| | | | |
|-----------------|------------|------------|------------|
| Model # | DG35HS | DJ35HS | DK35HS |
| Item # | 2013435000 | 2013535001 | 2013535000 |
| Shipping Weight | 180 lbs. | 225 lbs. | 257 lbs. |

47" Wide

| | | | |
|-----------------|------------|------------|------------|
| Model # | DG47HS | DJ47HS | DK47HS |
| Item # | 2013447000 | 2013547001 | 2013547000 |
| Shipping Weight | 282 lbs. | 280 lbs. | 283 lbs. |

Note: Cabinets without vents include one stainless steel shelf inside

Custom Designs Available Upon Request

Please email us at info@blickman.com

Cabinets

Customizable
Casework

DOUBLE BASE DRAWER CABINETS

Description: Our stainless steel double base drawer cabinets come in five different configurations and are designed to stand alone with finished sides or to fit within a framework of cabinets. They are all 35 3/4" tall and 22" deep, and come in two width sizes, 35" and 47".

Other Commonly Ordered Sizes: 29"W and 41"W



**-DP-
4 Drawer**



**-DS-
5 Drawer**

35" Wide

| | | |
|-----------------|------------|------------|
| Model # | DP35HS | DS35HS |
| Item # | 2013735000 | 2013735001 |
| Shipping Weight | 238 lbs. | 275 lbs. |

47" Wide

| | | |
|-----------------|------------|------------|
| Model # | DP47HS | DS47HS |
| Item # | 2013647000 | 2013747001 |
| Shipping Weight | 276 lbs. | 315 lbs. |



**-DT-
8 Drawer**



**-DR-
4 Small, 2 Large**



**-FC-
6 Small, 2 Large**

35" Wide

| | | | |
|-----------------|------------|------------|------------|
| Model # | DT35HS | DR35HS | FC35HS |
| Item # | 2013835000 | 2013635000 | 2013235002 |
| Shipping Weight | 287 lbs. | 265 lbs. | 275 lbs. |

47" Wide

| | | | |
|-----------------|------------|------------|------------|
| Model # | DT47HS | DR47HS | FC47HS |
| Item # | 2013847000 | 2013747000 | 2013247002 |
| Shipping Weight | 324 lbs. | 310 lbs. | 323 lbs. |

Custom Designs Available Upon Request

Please email us at info@blickman.com

Cabinets

Customizable
Casework

SINKS AND COUNTERTOPS

Please email us at info@blickman.com

Sink bowls come with moisture proof, sound-deadening mastic and are compatible with select base cabinets

Optional back/endsplashes (4" high) to protect wall surfaces



Counter top extends 1" past the front and past both sides of the base cabinet dimensions

Counter top is 304 stainless steel and comes standard with a Marine Edge to help protect against liquid slippage

Description: Our sinks and countertops must be ordered separately and are installed in the field. Most of our countertops are fabricated from one piece of fully welded, 16 gauge, 304 stainless steel. They extend 1" beyond the front, right, and left sides of base cabinet dimensions. Unless otherwise specified, they come with a Marine Edge to help protect against liquid slippage. Optionally, 4" high backsplashes and endsplashes are available to protect wall surfaces.

Base Cabinets Compatible with Additional Sink Bowl



AC

DB

AA

DA

DG

DJ

We suggest using Models AC and DB for moisture ventilation.

All piping and sink bowls can fit under any of these models with the door compartments and no drawers on top.

Cabinets

Customizable
Casework

DRAWER HOUSING

Please email us at info@blickman.com

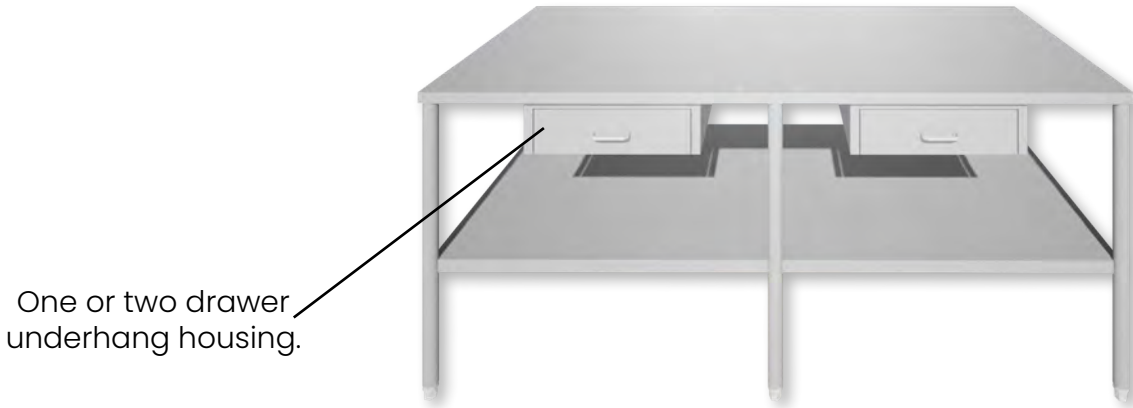

Description: You can use drawer housing to add a drawer or two under your countertop or tabletop surface. This helps increase storage space to prevent lack of access to equipment and supplies when stored separately. All drawer housing is 22" deep and reaches 5" below the underside of the countertop or tabletop. Width of drawer housing varies depending on size and number of drawers inside. The drawers are all 18 1/8" deep and 2 1/2" tall and come in two width sizes: 14 1/8" and 20 1/8".

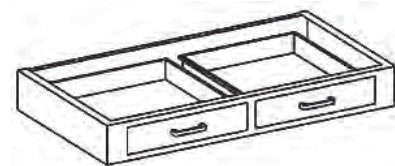
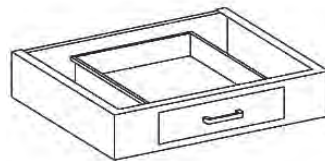

| Name Drawer & Housing Widths | Single Drawer | | Double Drawer | |
|---------------------------------|---------------------------------|---------------------------------|---------------------------------|---------------------------------|
| | 14 1/8"W Drawer 24"W Housing | 20 1/8"W Drawer 29"W Housing | 14 1/8"W Drawer 35"W Housing | 20 1/8"W Drawer 47"W Housing |
| Model # | DH124S | DH129S | DH235S | DH247S |
| Item # | 2043424000 | 2043429000 | 2043435000 | 2043447000 |
| Shipping Weight | 35 lbs. | 40 lbs. | 50 lbs. | 60 lbs. |

Custom Designs Available Upon Request
Please email us at info@blickman.com

Cabinets

CASEWORK
Options &
Accessories

OPTIONS



Sloped Top is available for all High Cabinets and Wall Cabinets. Listed below are the sloped tops that correspond to the cabinets with the standard dimensions shown in this previously in this section.

| Model # | Item # | Description | Shipping Weight |
|---------|------------|---|-----------------|
| ST-1818 | 5003518180 | Sloped Top for 18 ³ / ₄ "W High Cabinets (18 ³ / ₄ " x 11 ¹ / ₄ " x 18") | 24 lbs. |
| ST-3518 | 5003535180 | Sloped Top for 35"W High Cabinets (35" x 11 ¹ / ₄ " x 18") | 41 lbs. |
| ST-1813 | 5003518130 | Sloped Top for 18 ³ / ₄ " W Wall Cabinets (18 ³ / ₄ " x 8 ¹ / ₄ " x 13") | 21 lbs. |
| ST-3513 | 5003535130 | Sloped Top for 35" W Wall Cabinets (35" x 8 ¹ / ₄ " x 13") | 36 lbs. |

ACCESSORIES



Electronic Locking Systems available
for most of our cabinets



Additional Shelves, your choice of
stainless steel or glass

Custom Designs Available Upon Request
Please email us at info@blickman.com

Cabinets

Construction Specifications

| | |
|---------------------|---|
| Standard Dimensions | High Cabinets: 84" tall x 18" deep, widths vary Wall Cabinets: 30" tall x 13" deep, widths vary Base Cabinets: 35 3/4" tall x 22" deep, widths vary Countertops: 1" overhang in front and both sides of base cabinets |
| Materials | 304 Stainless Steel 1/4" clear tempered sheet glass |
| Gauge | Body, Sloped Top, Drawers, and Shelf Inserts: 18GA; Base: 16GA Glass Doors (Front and Back): 18GA Solid Doors (Front): 18GA; Solid Doors (Back): 20GA |
| Welding | All welding by heliarc method and exposed welds are ground smooth |
| Finish | Exposed surfaces are free from pit marks, weld seams, scale and are polished with #4 polish to a satin finish |
| Casters | N/A |
| Notes | <ul style="list-style-type: none">• Cabinet Parts:<ul style="list-style-type: none">• Hinge Doors: Hung on semi concealed stainless steel hinges and fitted with die cast aluminum bar pulls and spring loaded nylon roller catches.• Sliding Doors: Suspended from overhead ball bearing rollers, which are noiseless and self-lubricating, and ride in stainless steel guide strips fitted with die formed, recessed pulls securely welded in place.• Shelves: Constructed with a channel shaped, flanged edge and centers the full height of the cabinet.• Drawers: Drawer bodies are a one piece construction with covered corners. Drawer face equipped with die cast aluminum bar pole handles. Drawers operated on ball bearing roller slides with full extension.• High Cabinets & Wall Cabinets: Recessed pan back, 3/4" deep.• Base Cabinets: Each applied with a channel shaped base, incorporating toe space approximating 3" deep and 4" high, for easy cabinet access. Can be omitted when recessed or another base is used.• Sinks and Countertops: Fabricated in one piece, where possible, with welded corners, channel shaped exposed edges, and reinforced with three full length hat shaped galvaneal channels. |

Shipping Information

All shipping weights are estimates and may be changed without prior notice. Specifications may be improved and dimensions changed without prior notice. Please contact customer service for estimated shipping costs at info@blickman.com.

THE BLICKMAN DIFFERENCE

Console Cabinets

- Our console cabinets are designed with you in mind. Without taking up valuable floor space, choose these cabinets for storing a full scheduled day, protecting your sterile supplies behind closed doors, and allowing instant access to supplies and equipment to minimize procedural delays.
- We offer individual units that can be combined and assembled into your own custom console arrangements. You can easily design your own by selecting cabinets with solid or glass doors available with or without locks. Locks can be keyed alike or independently. Stainless steel perimeter recessing trim may be purchased with all built-in installations.
- We offer units with shelving, good for storing equipment and supplies and other units with pegboard backs, great for storing large pieces of equipment.
- We also offer a desk cabinet with drawers, a sloped writing surface, and a dry erase board.

Key Product Features

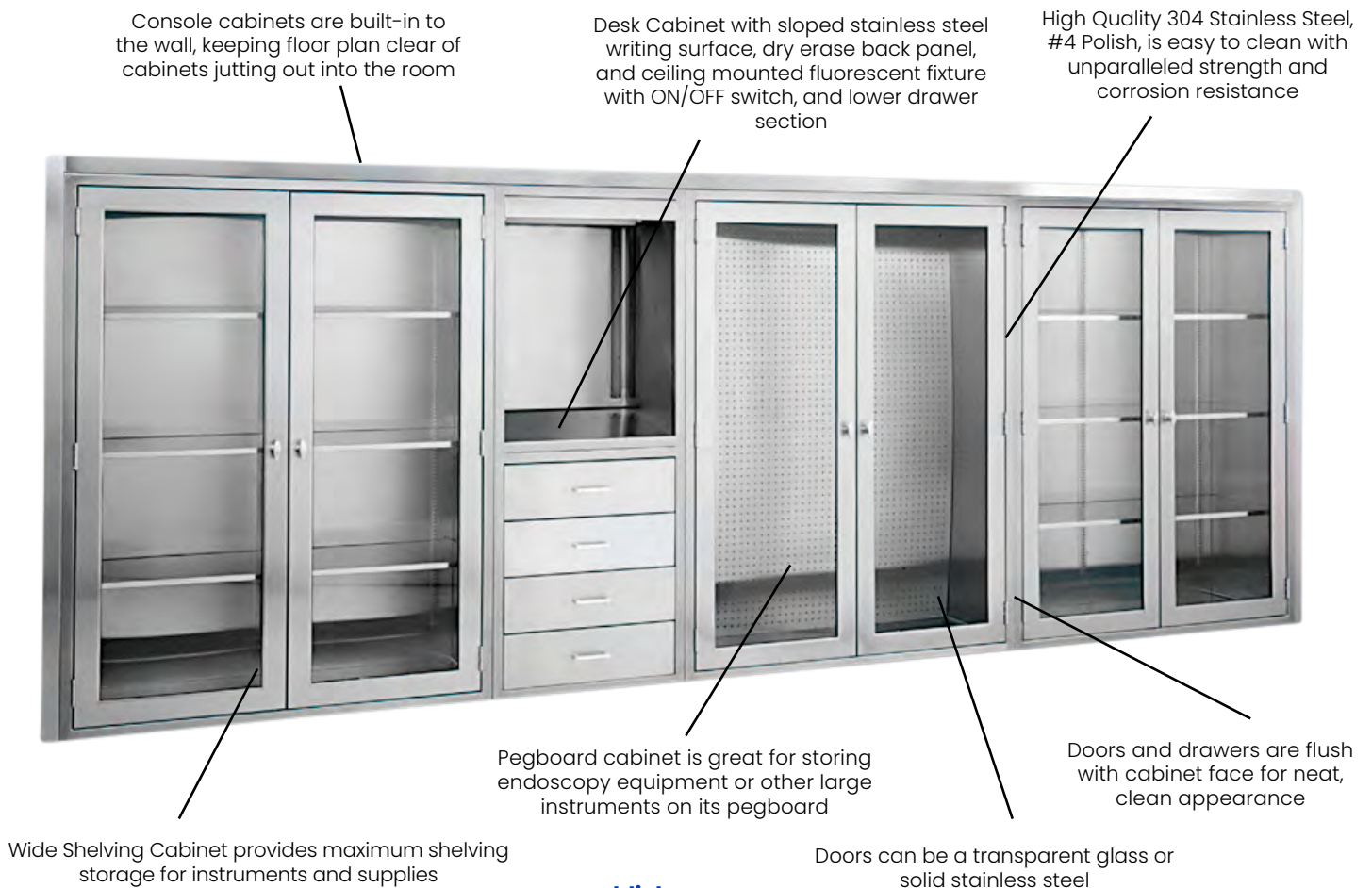

Cabinets

Console Cabinets

SINGLE WIDTH

Description: Our single width console cabinets are 24 1/8" x 60" x 18" and are designed as individual units that can be combined and assembled into your own custom console arrangements. All doors and shelves come in glass or solid stainless steel. Drawers are all stainless steel.

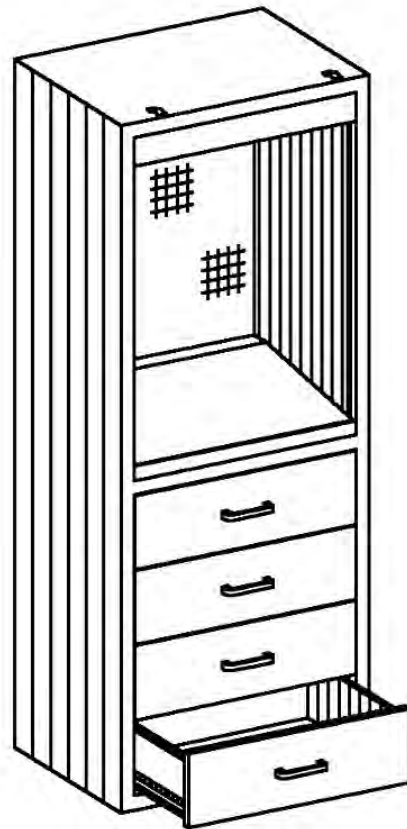
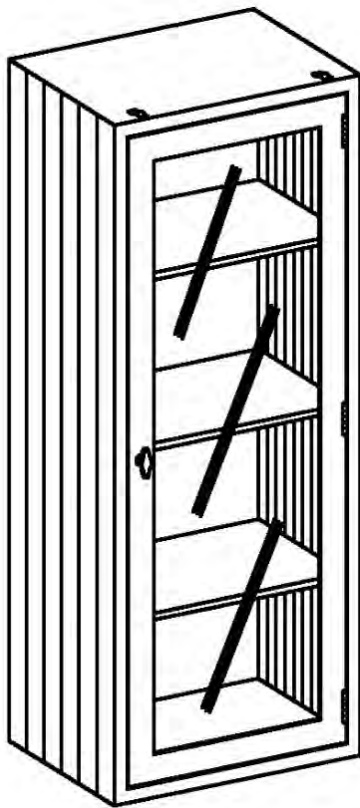

| Name | Miscellaneous Supply Cabinet | | Desk Console Cabinet |
|-----------------|------------------------------|------------|----------------------|
| | Glass Door | Solid Door | Drawers |
| Model # | MS24 | MS24S | DC24 |
| Item # | 1716724000 | 1716724258 | 1713224000 |
| Shipping Weight | 240 lbs. | 240 lbs. | 245 lbs. |

Custom Designs Available Upon Request
Please email us at info@blickman.com

Cabinets

Console Cabinets

DOUBLE WIDTH

Description: Our double width console cabinets are all designed as individual units that can be combined and assembled into your own custom console arrangements. All doors and shelves come in glass or solid stainless steel. They are both 60" high and 18" deep and come in two width sizes: 35" and 47".



| Name | Equipment & Supplies Console Cabinet | | Table Accessories Console Cabinet | |
|-----------------|--------------------------------------|------------|-----------------------------------|------------|
| | Glass Door | Solid Door | Glass Door | Solid Door |
| 35" W | | | | |
| Model # | ES35 | ES35S | TA35G | TA35 |
| Item # | 1713735000 | 1713735258 | 1718235010 | 1718235000 |
| Shipping Weight | 250 lbs. | 250 lbs. | 250 lbs. | 250 lbs. |
| 47" W | | | | |
| Model # | ES47 | ES47S | TA47G | TA47 |
| Item # | 1713747000 | 1713747258 | 1718247003 | 1718247000 |
| Shipping Weight | 275 lbs. | 275 lbs. | 355 lbs. | 355 lbs. |

Custom Designs Available Upon Request
Please email us at info@blickman.com

Cabinets

Console Cabinets

RECESSED WARMING CABINETS

Description: Our recessed warming cabinets are designed for built-in installation. Single chamber glass door, solid door, and passthrough models available. Three perforated stainless steel shelves come standard in these models.

Glass Door



Solid Door



Passthrough



Note: For the passthrough unit, the front door is glass, the back door is solid.

Dimensions

Width: 30" x Height: 60" x Depth: 20 5/8"

Electrical:

Amps: 7.5 | Total Wattage: 750

| Name | Glass Door | Solid Door | Passthrough |
|-----------------|------------|------------|-------------|
| Model # | SW40TG | SW40TS | SW40PTGS |
| Item # | 14BSW40243 | 14BSW40200 | 14BSW40278 |
| Shipping Weight | 320 lbs. | 320 lbs. | 245 lbs. |

Options: Dual chambers, alternative passthrough configurations.

Cabinets

CONSOLE CABINET
Accessories &
Options

ACCESSORIES

Cemented
Corner Guard,
16 gauge 304
stainless steel



Recess trim
available for
built-in console
cabinets

| Model # | Description | Shipping Weight |
|---------|---|-----------------|
| CG4448 | 48" High corner guards, for protection and corrosion resistance (4"x4"x48") | 20 lbs. |
| CG4496 | 96" High Corner guards, for protection and corrosion resistance (4"x4"x96") | 20 lbs. |
| Rt120 | Recessing trim, 22GA 304 stainless steel (10' strips, 1 1/2" x 1 1/2" wide) | 20 lbs. |



Electronic Locking Systems available
for most of our cabinets



Passthrough Cabinets available
for built-in applications

Custom Designs Available Upon Request
Please email us at info@blickman.com

Cabinets

CONSOLE CABINET
Construction
Specifications

Construction Specifications

| | |
|---------------------|---|
| Standard Dimensions | All console cabinets are 16" high x 18" deep, widths vary Exception: warming cabinets are 20" deep |
| Materials | 304 Stainless Steel 1/4" clear tempered sheet glass |
| Gauge | Body, Sloped Top, Drawers, and Shelf Inserts: 18GA Glass Doors: Front and Back: 18GA Solid Doors (Front): 18GA; Solid Doors (Back): 20GA |
| Welding | All welding by heliarc method and exposed welds are ground smooth |
| Finish | Exposed surfaces are free from pit marks, weld seams, scale and are polished with #4 polish to a satin finish |
| Casters | N/A |
| Notes | <ul style="list-style-type: none">• All Console Cabinets: Solid doors are double panned, channel reinforced. Glass doors come in double shell design, with one piece outer frames dieformed to receive rubber gasketed glass panels held in place by inner retaining strips.• Double Door Console Cabinets: Right door fitted with two point up and down knob latching, left hand door with integral stops, dummy knob, and spring loaded nylon roller catch. Doors operate on three semi-concealed stainless steel hinges. Pegboard Cabinet interiors (back and sides) are lined with removable 18GA stainless steel pegboard.• Desk Console Cabinet: Four drawers with double wall fronts operate on side mounted, two section ball bearing roller slides with built-in extension stops. Heads provided with diecast aluminum bar pulls.• Single Door Shelving Console Cabinet: Can be either right or left hinged.• Recessed Warming Cabinets: Temperature control from 90°F - 160°F. 160x180 pixel graphical display with dual colors (red/green). Built-in temperature data recorder with real time clock (RTC). |

Shipping Information

All shipping weights are estimates and may be changed without prior notice. Specifications may be improved and dimensions changed without prior notice. Please contact customer service for estimated shipping costs at info@blickman.com.

Blickman REVIT® Library

We have developed a library of our standard products using 3D Design Software REVIT®, which is available to your company at no charge.

Included in our Revit Library you can find:

Free standing Cabinets

Casework

Case Carts

Tables

Warming Cabinets

Visit: **www.blickman.com/revit-files**



Create your entire room from our cabinet files to discover a design that works best for your needs. We are happy to work with you to create custom cabinetry, casework, tables, etc. to fit in your space.

Custom Designs Available Upon Request

Please email us at info@blickman.com

BLICKMAN



Case Carts

Compact, stable, secure transport

Includes:

- Closed Case Carts
- Open Case Carts
- Shelving Options
- Accessories



THE BLICKMAN DIFFERENCE

- Operating room surgical staff can transport fully loaded case carts throughout the facility with the doors closed for increased protection and cart cleaning is a simple and easy task.
- We offer options that meet a variety of different surgery needs including neurosurgery, general surgery, outpatient surgery, labor and delivery, and more. We also offer space saving solutions that take up less floor space while being able to handle more extensive procedures.
- Our broad offering of case carts remains the most durable and highest functioning on the market. We are the only manufacturer in our class to offer a lifetime limited warranty. Our advanced engineering capabilities enable us to customize case cart designs to satisfy virtually any requirement your medical facility may have.
- The doors of the closed case carts swing a full 270° and a positive spring acting clip at the cart ends capture doors to stay in the open position during cart washing and while in use in the operating room.

Key Product Features

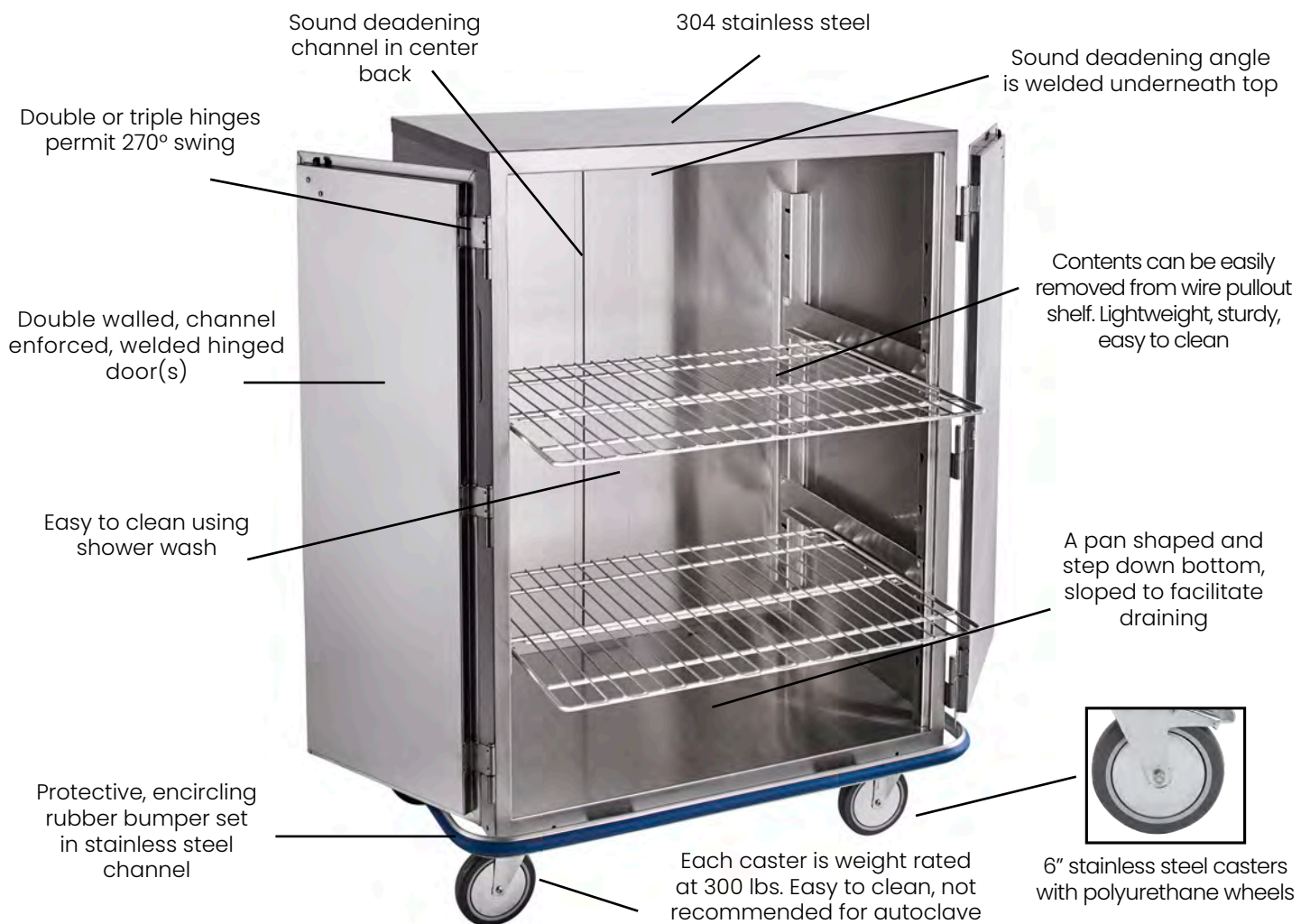

Case Carts

Maxi to Mini

Description: Our white maxi, multipurpose, and mini case carts differ in width, they are all 40 1/2" tall and 29" deep.. They each come standard with one wire shelf. The maxi case cart comes standard with a heavy duty roll-out shelf, and the multipurpose and mini case carts come with a lightweight pull-out shelf.

Maxi Cart

52" W

Ideal for procedures that require a larger volume of supplies such as neurosurgery and orthopedic surgery

Internal Dimensions:
42 7/8" W x 29 3/8" H x 25" D

Multipurpose Cart

42" W

Ideal size for most routine surgical procedures, whether or not your facility uses a container system

Internal Dimensions:
32 7/8" W x 29 5/8" H x 25" D

Mini Cart

29 5/8" W

Designed for labor and delivery and outpatient surgery, where a smaller cart is preferred

Internal Dimensions:
20 1/2" W x 29 5/8" H x 25" D

Push Handle



Name

Maxi

Multipurpose

Mini

Solid Doors

| | Maxi | Multipurpose | Mini |
|-----------------|------------------------|-----------------------|-------------------|
| Model # | CCC1-19 | CCC2-19 | CCC3-19 |
| Item # | 2293331000 | 2293332000 | 2293333000 |
| Floor Space | 10 1/2 ft ² | 8 1/2 ft ² | 6 ft ² |
| Shipping Weight | 266 lbs. | 225 lbs. | 168 lbs. |

Glass Doors

| | Maxi | Multipurpose | Mini |
|-----------------|-----------------------|----------------------|----------------------|
| Model # | CCC1-19G | CCC2-19G | CCC3-19G |
| Item # | 22933G1000 | 22933G2000 | 22933G3000 |
| Floor Space | 10.47 ft ² | 8.46 ft ² | 5.97 ft ² |
| Shipping Weight | 260 lbs. | 219 lbs. | 165 lbs. |



Custom Designs Available Upon Request

Please email us at info@blickman.com

Case Carts

Space Saving

Description: Our space saver case carts are designed to give a greater capacity while using the same floor space as the mini and multipurpose case carts. Their height and additional shelving provide additional storage capacity. Instead of 40 1/2" tall, they are 55 1/2" tall, and instead of one shelf, they come standard with two lightweight pull-out wire shelves.

Space Saving Cart

29 5/8" W

This cart can handle most routine surgical procedures.

Ultra Space Saving Cart

42" W

This cart can handle more extensive procedures.

Recessed Handle



Internal Dimensions:

20 1/2"W x 44 5/8"H x 25"D



Internal Dimensions:

32 7/8"W x 44 5/8"H x 25"D



Name

Space Saving

Ultra Space Saving

| Solid Doors | | |
|-----------------|-------------------|-----------------------|
| Model # | CCC4-19 | CCC5-19 |
| Item # | 2293334000 | 2293335000 |
| Floor Space | 6 ft ² | 8 1/2 ft ² |
| Shipping Weight | 208 lbs. | 276 lbs. |
| Glass Doors | | |
| Model # | CCC4-19G | CCC5-19G |
| Item # | 22933G4000 | 22933G5000 |
| Floor Space | 6 ft ² | 8 1/2 ft ² |
| Shipping Weight | 198 lbs. | 262 lbs. |

Custom Designs Available Upon Request

Please email us at info@blickman.com

Case Carts

Over The Road

Description: As healthcare processes change, Blickman works with customers to design the products they need. With growing demand for off-site sterile processing, Blickman reengineered its case cart lineup by adding a new series of carts dedicated to meet its customers' new and more demanding transport requirements.



**Ultra Space Saver - OTR5 is shown here with optional vertical side handles.*



| Name | Item # | Model # | Dimensions (WxHxD) | Floor Space | Shipping Weight |
|-------------------|------------|---------|----------------------|------------------------|-----------------|
| Maxi | 2327331030 | OTR1 | 53 x 42 x 29 | 10 1/2 ft ² | 266 lbs. |
| Multipurpose | 2327332030 | OTR2 | 43 x 42 x 29 | 8 1/2 ft ² | 225 lbs. |
| Mini | 2327333030 | OTR3 | 30 5/8 x 42 x 29 | 6 ft ² | 168 lbs. |
| Space Saver | 2327334030 | OTR4 | 30 5/8 x 56 3/4 x 29 | 6 ft ² | 208 lbs. |
| Ultra Space Saver | 2327335030 | OTR5 | 43 x 56 3/4 x 29 | 8 1/2 ft ² | 276 lbs. |

Custom Designs Available Upon Request
Please email us at info@blickman.com

Case Carts

Open

Description: Our open case cart designs are easy to clean, dry, load, and maneuver. The full encircling bumper and solid bottom prevents cross contamination. This design is ideal for carts that go directly to a sterile core, bypassing non-sterile transport.

Overall Dimensions:

Width: 42" x Height: 42" x Depth: 29"



| Name | Solid Shelves | Wire Shelves |
|-----------------|---------------|--------------|
| Model # | OCC3 | OCC4 |
| Item # | 2410396000 | 2410496000 |
| Shipping Weight | 219 lbs. | 141 lbs. |

Custom Designs Available Upon Request
Please email us at info@blickman.com



Case Carts

Interior Shelving

STANDARD

Wire Roll Out Shelf

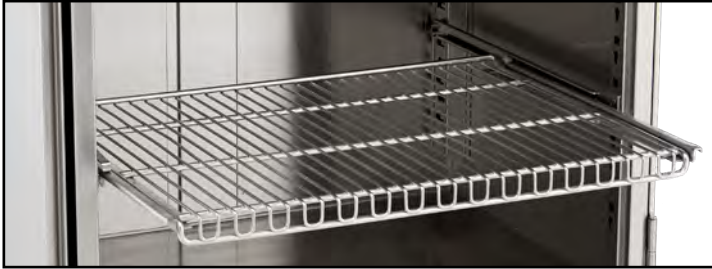

CCC1

Wire Pull Out Shelf



CCC2, 2E, 3, 4, and 5

OPTIONAL



Roll Out Shelving

Pull Out Shelving

| Case Carts | Wire | Perforated | Solid | Wire | Perforated | Solid |
|------------|------------|------------|------------|------------|------------|------------|
| CCC1 | 611C1RWKIT | 611C1RPKIT | 613C1RSKIT | N/A | 61517PIKIT | 61517S2KIT |
| CCC2/CCC5 | 610C2RWKIT | 610C2RPKIT | 610C2RSKIT | 6152272KIT | 6152275KIT | 6152274KIT |
| CCC3/CCC4 | 610C1RWKIT | 610C1RPKIT | 610C1RSKIT | 6152273KIT | 6152271KIT | 6152073KIT |



Case Carts

Exterior Shelving

EXTENSION SHELVES



Available on Model CCC2E Only

- Expand your work surface area -

DROP SHELVES



Compatible with CCC1, CCC2, & CCC3

- Expand your work surface area -

Custom Designs Available Upon Request

Please email us at info@blickman.com

Case Carts

Accessories

ACCESSORIES

Clean/Dirty Indicators



US Design Patent #: US D883,378 S
US Utility Patent#: US 10,643,505 B1



US Design Patent #: US D883,379 S
US Utility Patent#: US 10,643,505 B1

| Part # | Description | Shipping Weight |
|------------|-------------|-----------------|
| 5278628KIT | Angle Model | 2 lbs. |
| 5200045KIT | Dial Model | 2 lbs. |
| 5278618KIT | Pod Model | 2 lbs. |



Card Holder

We offer a 8.5" x 11" card holder. Custom sizes and placement options available. Stainless steel frame withstands prolonged use and cutouts allow for drainage.



Tote Boxes

Sturdy, long lasting tote boxes are ideal for organizing and storing small supplies that may slip through the spaces of wire shelves.

| Part # | Description | Shipping Weight |
|------------|-------------|-------------------------|
| 5206701185 | Card Holder | N/A - Factory Installed |
| 9854194720 | Tote Boxes | 5 lbs. |



Case Carts

Construction Specifications

Construction Specifications

| | |
|----------------------|---|
| Universal Dimensions | Closed Case Carts: 29" deep, varying widths. Standard Height: 40 1/2"; Space saving height: 55 1/2" Open Case Carts: 42" x 42" x 29" |
| Materials | 304 stainless steel, non-magnetic |
| Gauge | Closed Case Carts: Body & Doors: 18GA; Top & Chassis: 16GA Open Case Carts: Top & Bottom: 16GA; Shelf: 18GA Bumper Channel: 14GA |
| Welding | All welding by heliarc method and exposed welds are ground smooth |
| Finish | Exposed surfaces are free from pit marks, weld seams, scale and are polished with #4 polish to a satin finish |
| Casters | Four 6" stainless steel swivel casters with polyurethane wheels, weight rated at 300lbs (one with directional lock) |
| Notes | Found on next page |

Shipping Information

All shipping weights are estimates and may be changed without prior notice. Specifications may be improved and dimensions changed without prior notice. Please contact customer service for estimated shipping costs at info@blickman.com.

Custom Designs Available Upon Request

Please email us at info@blickman.com

Case Carts

Construction Specifications

Notes Continued

CLOSED CASE CARTS:

- **Body:** One piece top and one piece body. Sound deadening angle welded under the top. Sound deadening channel on the center back. A pan shaped, step down bottom with a slope that facilitates draining. Horizontal intersections filled with heat resistant silicone. The body shell is bolted to the chassis. A tubular push handle is provided at one end of the cart.

- **Doors:** Double walled, channel enforced, (double or triple) hinged doors with paddle latch pulls on leading edges. Doors less than 36" high swing on two hinges, while doors greater than 36" high swing on three hinges. All doors permit full 270° swing. In fully opened position, positive spring acting clips at the cart ends capture doors for cart washing or operating room use.

- **Shelves:** Shelves slide on adjustable stainless steel wires, suspended from keyhole punched standards welded to the cart interior.

OPEN CASE CARTS:

- **Frame:** U-shaped tubular framing formed around 3" radii or tubular corner posts stabilized and capped by a pan shaped top welded to posts at contact points. Posts are fitted with casters and either rolling bumpers or encircling rubber bumpers.

- **Tops, bottoms, fixed shelves:** Fabricated with turned down edges, either hemmed or flanged, with corners notched to sit over or snugly against the inside contour of the upright members. Notched corners are fully welded to the uprights the full height of the facing edges as well as around the notch.

- **Adjustable shelves:** Solid rods welded between the tubular uprights at each end, stabilizing the framing members while providing varying levels of shelf adjustment.

Custom Designs Available Upon Request

Please email us at info@blickman.com

BLICKMAN



Chairs

Providing ultimate comfort and function

Includes:

- Patient Room Chairs
- Waiting Room Chairs



THE BLICKMAN DIFFERENCE

Chairs

- Our patient chairs come in our same washable vinyl (75 colors available - see upholstery catalog) and are designed to be used in patient rooms and offices that require easy-to-clean, sterile environments.
- Our waiting room chairs come in our new 100% Polyester fabric (19 colors available - see upholstery catalog) and are designed to be used in more comfortable and inviting environment such as waiting areas.
- All of our chairs include a backrest and four black washable plastic legs. We offer a standard size with and without arm rests.

Key Product Features



Chairs

Patient & Waiting Room

Patient Room Chairs: Our patient room chairs come in our vinyl fabric for comfortable seating designed for use in patient exam rooms, offices, hallways, and other areas of your facilities that require sterilization.

Waiting Room Chairs: Our waiting room chairs come in our polyester fabric for more comfortable and inviting environments such as waiting areas.

Sizes: Our standard chair size is 24" x 33" x 22 5/8", comes with or without arm rests and has a weight capacity of 300 lbs.



| Name | Chair | Chair with Arms |
|-----------------|---|-----------------|
| Fabric | Vinyl (Patient Room Chairs) | |
| Model # | 1130 | 1130WA |
| Item # | 1051130000 | 1051130100 |
| Shipping Weight | 18 lbs. | 21 lbs. |
| Fabric | Polyester Fabric (Waiting Room Chairs) | |
| Model # | 1120 | 1120WA |
| Item # | 1051120000 | 1051120100 |
| Shipping Weight | 18 lbs. | 21 lbs. |

Options: 75 vinyl colors and 19 polyester fabric colors- see upholstery catalog

Chairs

Construction Specifications

Construction Specifications

Standard Dimensions

Standard Seat: Width: 24" x Height: 33" x Depth: 22 5/8"

Materials

Arms and Legs: Black Plastic

Seats: 75 vinyl colors or 19 polyester fabric colors - see upholstery catalog

Gauge

N/A

Welding

N/A

Finish

N/A

Casters

N/A

Shipping Information

All shipping weights are estimates and may be changed without prior notice. Specifications may be improved and dimensions changed without prior notice. Please contact customer service for estimated shipping costs at info@blickman.com.

Toll Free: (800) 247-5070
Local: (973) 330-0557

BLICKMAN

www.blickman.com
info@blickman.com

1099 Wall Street West, Suite 250A, Lyndhurst, NJ 07071

BLICKMAN



Exam Stools

Providing ultimate comfort and function

Includes:

- Spindle Adjusted Stools
- Pneumatic Stools
- Parts & Accessories



THE BLICKMAN DIFFERENCE

EXAM STOOLS

- Our durable, high quality chrome and stainless steel exam stools come with 3" thick, dense foam 15" diameter cushion for ultimate comfort.
- Our upholstery is washable vinyl and is available in an array of 75 fashion colors that meet specific design requirements - see upholstery catalog for details.
- For applications that require the longevity that stainless steel provides, pick from our revolving stools, or for a more modern look, choose from four or five leg models with spindle adjusted or pneumatic lift mechanisms.
- For back support, choose one of our models with a back rest.
- Our three styles of locking casters allow for easy mobility and safety.

Key Product Features



Exam Stools

Spindle

4 LEG SPINDLE EXAM STOOLS

Description: We offer two four leg spindle adjusted exam stools with the option of 2" casters or rubber crutch tips. Choose our Passaic stool and sit comfortably on a 15" diameter, 3" thick polyfoam padded seat upholstered in vinyl or choose our Clifton stool for an easy-to-clean stainless steel seat with a non-slip vinyl insert. Add a removable pad slipcover to your Clifton stool for a more comfortable option.

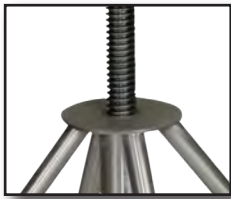

Spindle

Adjusts 12"
Rubber Tips: 19" - 31"
Casters: 21" - 33"



Name

CLIFTON

PASSAIC

Standard

With Pad

Standard

Casters

| | | | |
|-----------------|------------|------------|------------|
| Model # | 7745SS-C | 7745SS-PC | 7714-PSSC |
| Item # | 1027745001 | 1027745003 | 1027714125 |
| Shipping Weight | 17 lbs. | 17 lbs. | 17 lbs. |

Crutch Tips

| | | | |
|-----------------|------------|------------|------------|
| Model # | 7745SS | 7745SS-P | 7714-PSS |
| Item # | 1027745000 | 1027745002 | 1027714025 |
| Shipping Weight | 16 lbs. | 16 lbs. | 16 lbs. |



Options: Available in standard black. Consult factory for requests in other colors for large order quantities

Exam Stools

Spindle

5 LEG SPINDLE EXAM STOOL

Description: Our five leg spindle exam stool rests on a 24" diameter base. Choose between a black composite base or an aluminum base with Wall Saver™ tips on the ends to protect against scuff marks and offer a textured surface for foot grip. Sit comfortably on its 15" diameter, vinyl upholstered seat with 3" thick polyfoam padding. This model is available with or without a back.



Spindle

Adjusts 5 7/8"
Height: 20 7/8" - 26 3/4"



Name

5 Leg Spindle Stool

**5 Leg Spindle Stool
with backrest**

Aluminum Base

| | | |
|-----------------|------------|------------|
| Model # | 1113 | 1113WB |
| Item # | 1021113000 | 1021113200 |
| Shipping Weight | 22 lbs. | 26 lbs. |

Black Composite Base

| | | |
|-----------------|------------|------------|
| Model # | 1113BLK | 1113WB-BLK |
| Item # | 1021113100 | 1021113300 |
| Shipping Weight | 22 lbs. | 26 lbs. |

Options: Foot ring, 75 different vinyl colors - see upholstery catalog

Exam Stools

Pneumatic

FOOT OPERATED EXAM STOOL

Description: Our five-leg foot operated exam stool have a push ring under a 24" diameter aluminum base with Wall Saver™ tips on the ends to protect against scuff marks and offer a textured surface for foot grip. Sit comfortably on its 15" diameter, vinyl upholstered seat with 3" thick polyfoam padding. This model is available with or without a back.



Foot Pedal

Adjusts 7"
Height: 18 3/8" - 25 3/8"



| Name | Foot Operated Stool | Foot Operated Stool with Backrest |
|-----------------|----------------------|-----------------------------------|
| | Aluminum Base | |
| Model # | 1205 | 1206 |
| Item # | 1041205000 | 1041206000 |
| Shipping Weight | 22 lbs. | 28 lbs. |

Options: Foot ring, 75 different vinyl colors - see upholstery catalog

Exam Stools

Pneumatic

HAND OPERATED EXAM STOOLS

Description: Our five-leg hand operated exam stool rests on a 24" diameter base. Choose between a black composite base or an aluminum base with Wall Saver™ tips on the ends to protect against scuff marks and offer a textured surface for foot grip. Sit comfortably on its 15" diameter, vinyl upholstered seat with 3" thick polyfoam padding. This model is available with or without a back.

Standard Stools



Hand Lift

Adjusts 7"
Height: 18 3/8" - 25 3/8"



| Name | Hand Operated Stool | Hand Operated Stool with Backrest | |
|-----------------|----------------------|-----------------------------------|------------|
| | Aluminum Base | | |
| Model # | 1210 | 1210WB | |
| Item # | 1041210000 | 1041210200 | |
| Shipping Weight | 22 lbs. | 26 lbs. | |
| Name | Black Composite Base | | |
| | Model # | 1210BLK | 1210WB-BLK |
| | Item # | 1041210100 | 1041210300 |
| Shipping Weight | 22 lbs. | 26 lbs. | |

Options: Foot ring, 75 different vinyl colors - see upholstery catalog



Exam Stools

Pneumatic

HAND OPERATED EXAM STOOLS

Economy Stools

Description: Our economy hand operated exam stool rests on a 24" diameter black composite base with black plastic twin wheel casters. Sit in comfort on a 15" diameter, vinyl upholstered seat with 3" thick polyfoam padding. this model is available with and without a back.

Adjusts 7" from 18 3/8" to 25 3/8" off the ground



| Name | Economy Stool | |
|-----------------|---------------|------------|
| | Without Back | With Back |
| Model # | 1200 | 1201 |
| Item # | 1041200100 | 1041201300 |
| Shipping Weight | 22 lbs. | 26 lbs. |

Options: Foot ring, 73 different vinyl colors - see upholstery catalog

Deluxe Stools

Description: Our deluxe hand operated exam stool comes standard with a foot ring for leg-joint comfort. These stools rest on a 24" diameter black composite or aluminum base, which comes with Wall Saver™ tips to protect against scuff marks and offer a textured surface for foot grip. Both bases travel easily on 2" hard rubber casters. Sit in comfort on a 15" diameter, vinyl upholstered seat with 3" thick polyfoam padding with a backrest.

Adjusts 7" from 21 3/8" to 28 3/8" off the ground



| Name | Deluxe Stool | |
|-----------------|---------------|----------------------|
| | Aluminum Base | Black Composite Base |
| Model # | 1212 | 1212BLK |
| Item # | 1041212000 | 1041212100 |
| Shipping Weight | 29 lbs. | 29 lbs. |

Options: 75 different vinyl colors - see upholstery catalog

Foot Ring as an Accessory: Compatible on all 5 leg stools

| Part # | Description | Shipping Weight |
|------------|---------------------------------|-----------------|
| 7901243000 | Foot Ring for Leg Joint Comfort | 6 lbs. |





Exam Stools

Construction Specifications

Construction Specifications

| | |
|---------------------|---|
| Standard Dimensions | Seats: 15" diameter Polyfoam padding: 3" thick Height Range: 18" - 33" |
| Materials | Bases: Aluminum or black composite Seats: 75 colors of upholstered vinyl covering polyfoam padding. Clifton/Passaic Stool: 304 stainless steel |
| Gauge | Clifton Stool Legs: 18GA; Clifton Stool Seat: 14 GA Passaic Stool Legs : 18 GA |
| Welding | Clifton/Passaic Stool: All welding by heliarc method and exposed welds are ground smooth |
| Finish | Clifton/Passaic Stool: Exposed surfaces are free from pit marks, weld seams, scale and are polished with #4 polish to a satin finish |
| Casters | 2" hard rubber casters or 2" twin wheel plastic casters |
| Notes | <ul style="list-style-type: none"> • MR conditional stool available. See MR conditional catalog • For all vinyl colors, please see our upholstery catalog |

Shipping Information

All shipping weights are estimates and may be changed without prior notice. Specifications may be improved and dimensions changed without prior notice. Please contact customer service for estimated shipping costs at info@blickman.com.

Toll Free: (800) 247-5070
Local: (973) 330-0557



www.blickman.com
info@blickman.com

1099 Wall Street West, Suite 250A, Lyndhurst, NJ 07071

MR Conditional

Exam Stools

EXAM STOOL

Description: Our MR conditional exam stool is industry standard, fully welded, stainless steel construction. Sit comfortably on 15" diameter, 3" thick padded seats. Choose between stationary feet tips or casters for mobility. Height is 21" on feet tips and 23" on MR casters.



| Name | MR Conditional Stool | MR Conditional Stool with Casters |
|-----------------|----------------------|-----------------------------------|
| Item # | 7445MR | 7445MR-C |
| Model # | 1027445000 | 1027445001 |
| Shipping Weight | 14 lbs. | 16 lbs. |



Exam Stools

Construction
Specifications

Construction Specifications

| | |
|---------------------|---|
| Standard Dimensions | Seats: 15" diameter Polyfoam padding: 3" thick Height Range: 18" - 33" |
| Materials | Bases: Aluminum or black composite Seats: 75 colors of upholstered vinyl covering polyfoam padding. Clifton/Passaic Stool: 304 stainless steel |
| Gauge | Clifton Stool Legs: 18GA; Clifton Stool Seat: 14 GA Passaic Stool Legs : 18 GA |
| Welding | Clifton/Passaic Stool: All welding by heliarc method and exposed welds are ground smooth |
| Finish | Clifton/Passaic Stool: Exposed surfaces are free from pit marks, weld seams, scale and are polished with #4 polish to a satin finish |
| Casters | 2" hard rubber casters or 2" twin wheel plastic casters |
| Notes | <ul style="list-style-type: none"> • MR conditional stool available. See MR conditional catalog • For all vinyl colors, please see our upholstery catalog |

Shipping Information

All shipping weights are estimates and may be changed without prior notice. Specifications may be improved and dimensions changed without prior notice. Please contact customer service for estimated shipping costs at info@blickman.com.

BLICKMAN



Foot Stools

Safe and sturdy to step up or down

Includes:

- 8" High Foot Stools
- 9" High Foot Stools
- Two Step Foot Stools
- EZ Stacking Stools + Dolly



THE BLICKMAN DIFFERENCE

- Whether chrome or stainless steel, our foot stools are high quality, durable, and safe.
- Every foot stool includes a non-slip rubber tread for secure footing and non-slip rubber tips on the stools' feet to secure floor placement.
- For heavy loads, some models include H-brace reinforcement.
- For additional user stability, some models include handrails or allow for the addition of a handrail.
- MR conditional options are also available.

Key Product Features

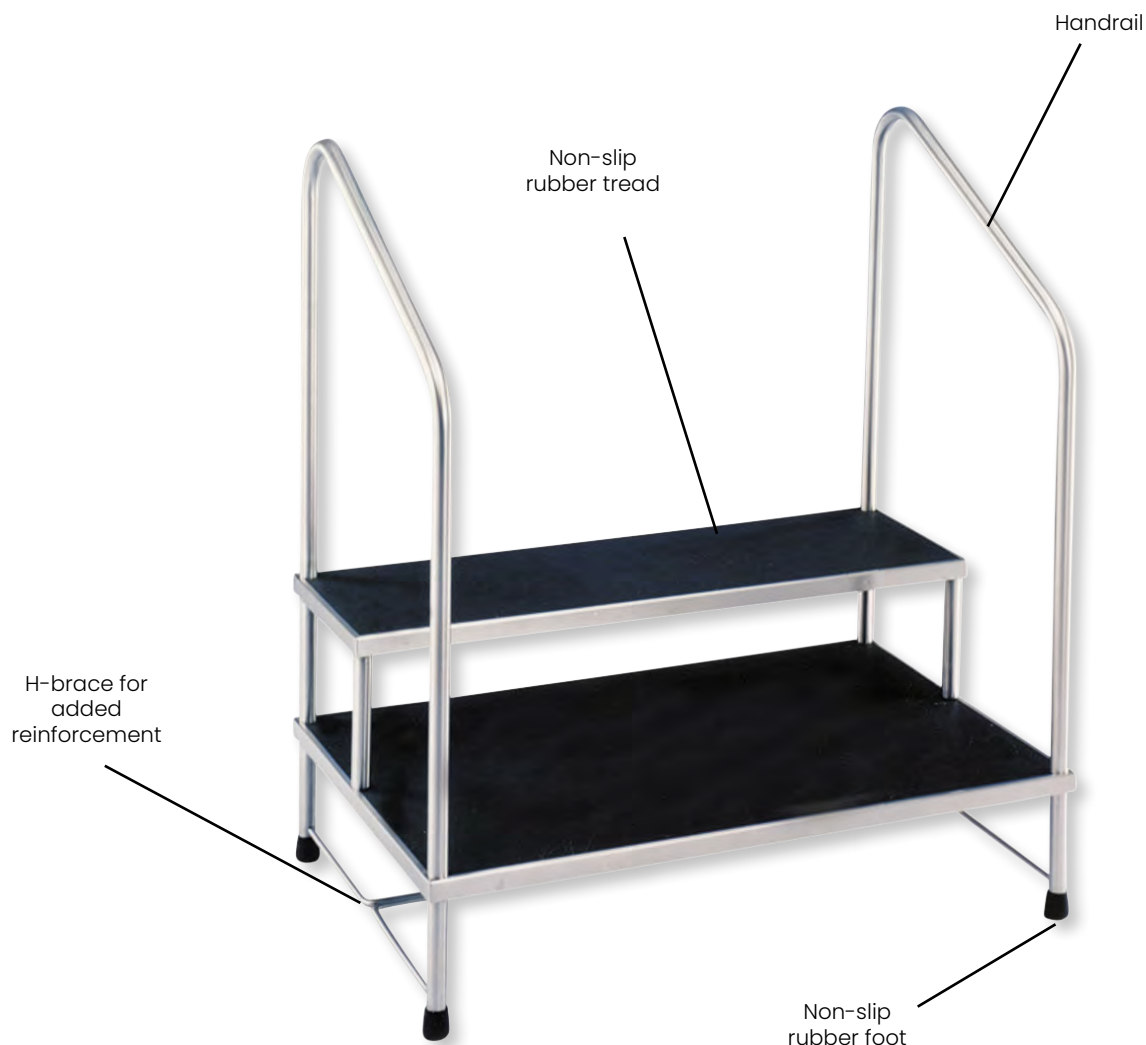

Foot Stools

One Step

8" HIGH FOOT STOOLS

Description: Our MR conditional approved Kent foot stools include one step 8" off the ground. They are industry standard, fully welded, stainless steel construction with non-slip rubber treads and feet tips. 18" and 30" width sizes are available. Depth is 12". Include a 41" tall handrail for additional support.

8" stools have the same dimensions:

Width: 18" or 30" x Height: 8" x Depth: 12"



**18" Wide
Kent Stool**

**30" Wide
Kent Stool**

| Name | 18"W | 30"W |
|-------------------------|------------|------------|
| With Handrail | | |
| Model # | 7757MR-HR | 7761MR-HR |
| Item # | 1017757100 | 1017761100 |
| Shipping Weight | 20 lbs.* | 30 lbs.* |
| Without Handrail | | |
| Model # | 7757MR | 7761MR |
| Item # | 1017757000 | 1017761000 |
| Shipping Weight | 11 lbs. | 20 lbs. |

*Shipping weight with an asterisk is the combined shipping weight of separate parts

Foot Stools

One Step

9" HIGH FOOT STOOLS

Description: Our 9" high foot stools come in either chrome or stainless steel and consist of one step 9" off the ground with non-slip rubber treads and feet tips. A 35 3/4" tall handrail for additional support is available for the chrome stool.

All 9" stools have the same dimensions:

Width: 14 1/4" x Height: 9" x Depth: 11 3/8"



Stainless Steel Stool



Chrome Stool

| Name | Stainless Steel Stool | Chrome Stool |
|-----------------|-------------------------|--------------|
| | With Handrail | |
| Model # | 1261 | 1251 |
| Item # | 1011261000 | 1011251000 |
| Shipping Weight | 12 lbs.* | 11 lbs.* |
| | Without Handrail | |
| Model # | 1260SS | 1250 |
| Item # | 1011260000 | 1021251640 |
| Shipping Weight | 8 lbs. | 7 lbs. |

*Shipping weight with an asterisk is the combined shipping weight of separate parts

Foot Stools

Two Step

TWO STEP FOOT STOOLS

Description: Our MR conditional approved two step foot stools are industry standard, fully welded, stainless steel construction with H-braces for additional reinforcement, non-slip rubber treads for secure footing, and feet tips for firm floor placement.



Step Surface Areas
 Top Step: 36" x 12"
 Bottom Step: 36" x 24"

Heights of Steps
 Top Step: 15 3/4"
 Bottom Step: 8"

| Name | 2-Step Foot Stool |
|-----------------|----------------------------------|
| | With Handrails (41" high) |
| Model # | 7764MR-HR |
| Item # | 1012041096 |
| Shipping Weight | 65 lbs. |

Two Step Foot Stool with Side Handrails



Step Surface Areas
 Top Step: 24" x 8"
 Bottom Step: 24" x 16"

Heights of Steps
 Top Step: 15 3/4"
 Bottom Step: 8"

| Name | The Donnelly |
|-----------------|----------------------------------|
| | With Handrails (41" high) |
| Model # | 7763MR-HR |
| Item # | 1017763100 |
| Shipping Weight | 40 lbs.* |
| | Without Handrail |
| Model # | 7763MR |
| Item # | 1017763000 |
| Shipping Weight | 27 lbs. |

The Donnelly with Handrail

*Shipping weight with an asterisk is the combined shipping weight of separate parts

Foot Stools

EZ Stacking

OUR EZ Stacking Stool allows you to:

- ✓ Create wider platforms by locking side-to-side
- ✓ Create higher platforms by stacking top-to-bottom
- ✓ Store efficiently and transport easily with our corresponding dolly

EZ STACKING STOOLS



Description: Our EZ stacking stools and dolly are made with our durable stainless steel. The stools are covered with a non-slip rubber tread and feet tips.



EZ Stool Dimensions:
18 7/8" x 6 1/4" x 13 7/8"



Dolly Dimensions:
21 1/2" x 39" x 16 1/2"

| Name | EZ Stacking Stool | Dolly |
|-------------|-------------------|------------|
| Model # | 8862SS | 8862SS-D |
| Item # | 1018862000 | 1018862300 |
| Ship Weight | 14 lbs. | 20 lbs. |

Foot Stools

Construction Specifications

Construction Specifications

| | |
|---------------------|---|
| Standard Dimensions | 1 step: 6 1/4" - 9" high 2 step: Bottom step: 8" high, Top step: 15 3/4" high |
| Materials | Chrome 304 stainless steel Black non-slip rubber |
| Gauge | EZ Stacking Stools: 16GA platform, 14GA legs All Stainless Steel Stools: 16GA (Exception: 7757MR-HR and 7761MR-HR have 18GA handrails) |
| Welding | All welding by heliarc method and exposed welds are ground smooth |
| Finish | Exposed surfaces are free from pit marks, weld seams, scale and are polished with #4 polish to a satin finish |
| Casters | Dolly: 3" swivel casters with no brakes |
| Notes | MR conditional foot stools are available where indicated |

Shipping Information

All shipping weights are estimates and may be changed without prior notice. Specifications may be improved and dimensions changed without prior notice. Please contact customer service for estimated shipping costs at info@blickman.com.

Note for: *1251 Stool* Parts shipped separately to avoid damage and lower costs. Shipping weight with asterisk is the combined shipping weight of separate parts. Some assembly required.

BLICKMAN



Hampers

For elimination of dirty linens

Includes:

- Round Hampers
- Square Hampers
- Space Saver Hamper
- Hamper Bags



THE BLICKMAN DIFFERENCE

- Our hampers facilitate easy and safe disposal of contaminated linens. They all move easily over floors on 2" or 3" casters. Our hampers have proven to be stable when empty or full due to their wide bases and added counterweights on covered models. A bottom brace holds and protects the hamper bag from contact with the floor.
- Our hampers come in either chrome or stainless steel and we offer different shapes and sizes to fit your needs and floor plans. Additionally, we offer covered models to control airborne pathogens. All covered hampers are foot-operated to help prevent cross contamination.
- For MR conditional environments, we offer two MR conditional models: one covered and one uncovered, for your choosing.
- We offer two optional hamper bags, nylon and water soluble, that fit our round hampers.

Key Product Features

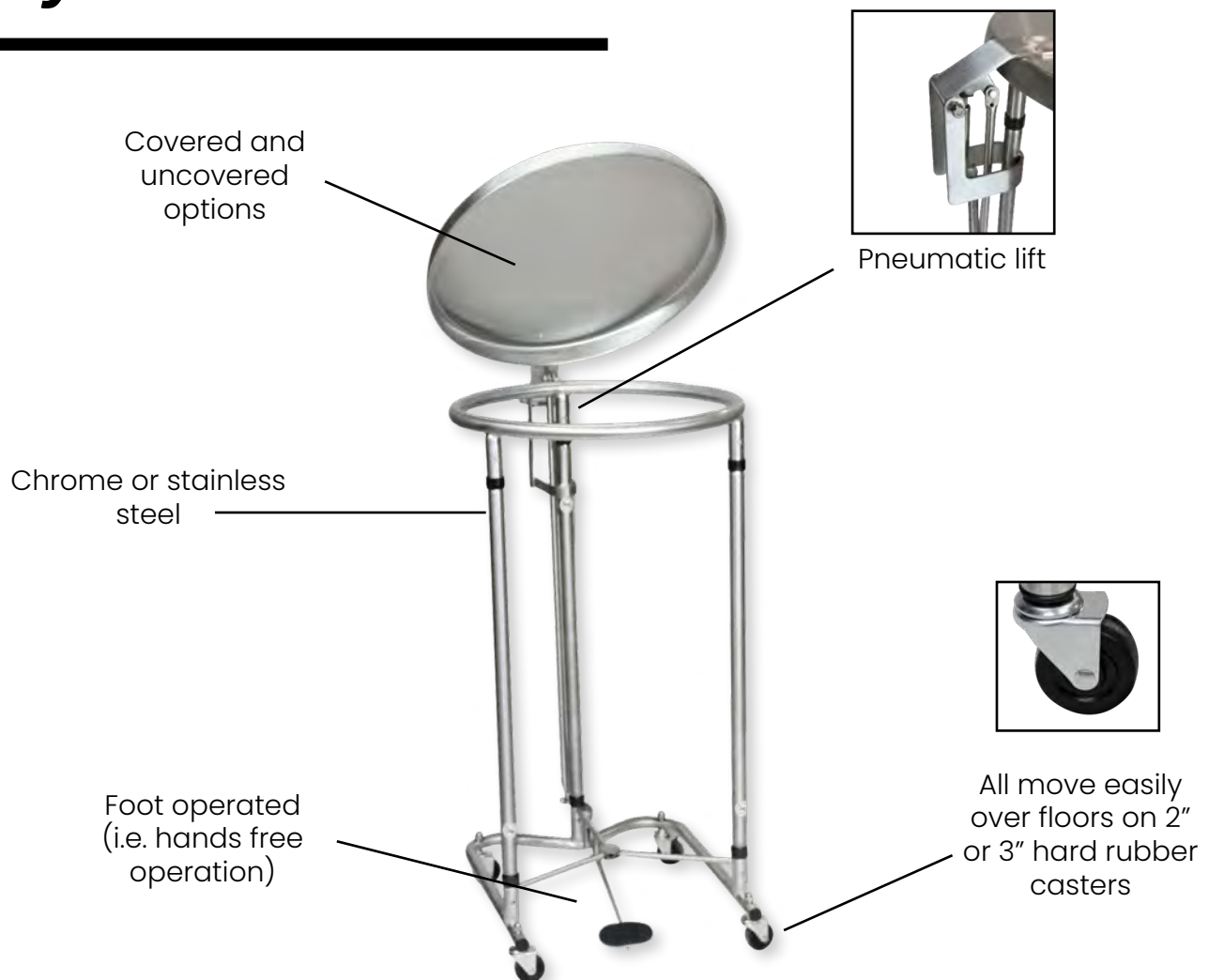

Hampers

Round

ROUND HAMPERS

Description: We offer covered and uncovered round hampers in both stainless steel and chrome. They are 35" tall and roll on 2" hard rubber swivel casters. They come in two sizes 18" diameter and 25" diameter. The covered models operate via a spring-loaded lift mechanism that opens and closes the stainless steel lid. The pneumatic top allows for pin drop quiet operation.

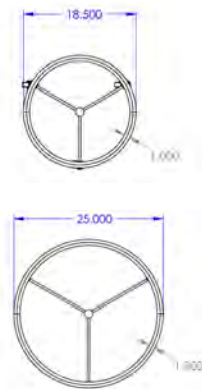

| Name | Uncovered | | Covered | |
|-----------------|------------|-----------------|------------|-----------------|
| | Chrome | Stainless Steel | Chrome | Stainless Steel |
| Bag Size | 18" | | | |
| Model # | 2018 | 7774SS | 2118 | 7774SS-LF |
| Item # | 0962018000 | 0927774000 | 096211800P | 092777420P |
| Shipping Weight | 11 lbs. | 11 lbs. | 21 lbs. | 25 lbs. |
| Bag Size | 25" | | | |
| Model # | 2025 | 8773SS | N/A | 8773SS-LF |
| Item # | 0962025000 | 0928773000 | N/A | 092877320P |
| Shipping Weight | 12 lbs. | 13 lbs. | N/A | 35 lbs. |

Hamper Bags: 18" and 25" white nylon hamper bags and water soluble hamper bags.

Hampers

Square

FOLDING ADJUSTABLE HAMPER

Description: Our folding chrome hamper adjusts to accommodate three hamper bag sizes with a bottom frame to support hamper bags. Travels on 2" hard rubber swivel casters.



Dimensions:

- **18" bag size:** 19" x 36 1/2" x 18"
- **22" bag size:** 19" x 40 1/2" x 22"
- **25" bag size:** 19" x 42 1/4" x 25"

| Name | Folding Adjustable Hamper |
|-----------------|---------------------------|
| Model # | 2230 |
| Item # | 0962230000 |
| Shipping Weight | 18 lbs. |

SECURE CARE HAMPER

Description: Our secure care chrome hamper supports 36 - 42 gallon multipurpose bags. Its' polycoated steel lid opens using foot operated lift mechanism. Includes hamper storage pouch. Travels on 3" hard rubber swivels casters.



Dimensions:

- 18 5/8" x 37 3/4" x 19 1/2"

| Name | Secure Care Hamper |
|-----------------|--------------------|
| Model # | 2010 |
| Item # | 0962010000 |
| Shipping Weight | 26 lbs. |

Hampers

Triangular

SPACE SAVER HAMPER

Description: Our space saver hamper offers hands free loading and unloading with a convenient non-slip foot pedal. Sturdy all stainless steel construction with bumper guards on lid and legs to protect equipment and walls. The solid bottom shelf provides extra security for heavy loads and a spring-loaded lift mechanism provides a pin-drop pneumatic top for quiet operation. Travels on 3" hard rubber swivel casters.



| Name | Space Saver Hamper |
|-----------------|--------------------|
| Model # | 230ISS |
| Item # | 096230100P |
| Shipping Weight | 24 lbs. |

MR Conditional

Hamper

HAMPER

Description: Our MR conditional round stainless steel hamper travels easily on 2" MR casters and is compatible with our 18" nylon hamper bags and our water soluble hamper bags.



| Name | MR Conditional Hamper |
|-----------------|-----------------------|
| Model # | 7772MR |
| Item # | 0927772400 |
| Shipping Weight | 20 lbs. |

Hampers

Accessories

HAMPER BAGS



**Disposable Water Soluble
Plastic Hamper Bag**



**Reusable
Nylon Hamper Bag**



**Secure Care
Hamper Pouch**

| Part # | Description | Shipping Weight |
|------------|---|-----------------|
| 98390000WS | 100 Plastic Water Soluble Hamper Bags | 9 lbs. |
| 9839777201 | Bag, 18" Diameter Ring Hamper Nylon White | 1 lb. |
| 9839777302 | Bag, 25" Diameter Ring Hamper Nylon White | 1 lb. |
| 0962012000 | Secure Care Hamper Pouch for Labels | 1 lb. |

Hampers

Construction Specifications

Construction Specifications

| | |
|----------------------|---|
| Universal Dimensions | Hamper Bag Sizes: 18", 22", 25", 26" |
| Materials | 304 stainless steel Chrome |
| Gauge | Stainless Steel: 1" diameter, 18GA tubing Chrome: 1" diameter tubing |
| Welding | All welding by heliarc method and exposed welds are ground smooth |
| Finish | Exposed surfaces are free from pit marks, weld seams, scale and are polished with #4 polish to a satin finish |
| Casters | 2" & 3" hard rubber swivel casters (some with locks) |
| Notes | MR conditional hampers available where indicated |

Shipping Information

All shipping weights are estimates and may be changed without prior notice. Specifications may be improved and dimensions changed without prior notice. Please contact customer service for estimated shipping costs at info@blickman.com.

BLICKMAN



IV Stands

Optimal continuous fluid delivery

Includes:

- IV Stands
- IV Stand Accessories
- IV Irrigation Safety Systems



THE BLICKMAN DIFFERENCE

IV Stands

- Our IV poles are optimal for maintaining continuous fluid delivery for every patient, available in a wide range of adjustable heights with a variety of easy locking options that can be operated with one hand.
- Our IV poles are all available in high quality chrome and stainless steel, and set on 4, 5, or 6 leg bases with casters, no projections, and great balance/tip resistance. Some bases are gravity weighted to help compensate for heavier loads. All bases have the ability to spin 360° in tight spaces.
- Most of our models have 2-, 4-, 6- and 8-(rake) hook adapters available. All come with colored secure grip tips.

Key Product Features

*See page 9 for more details on all optional features

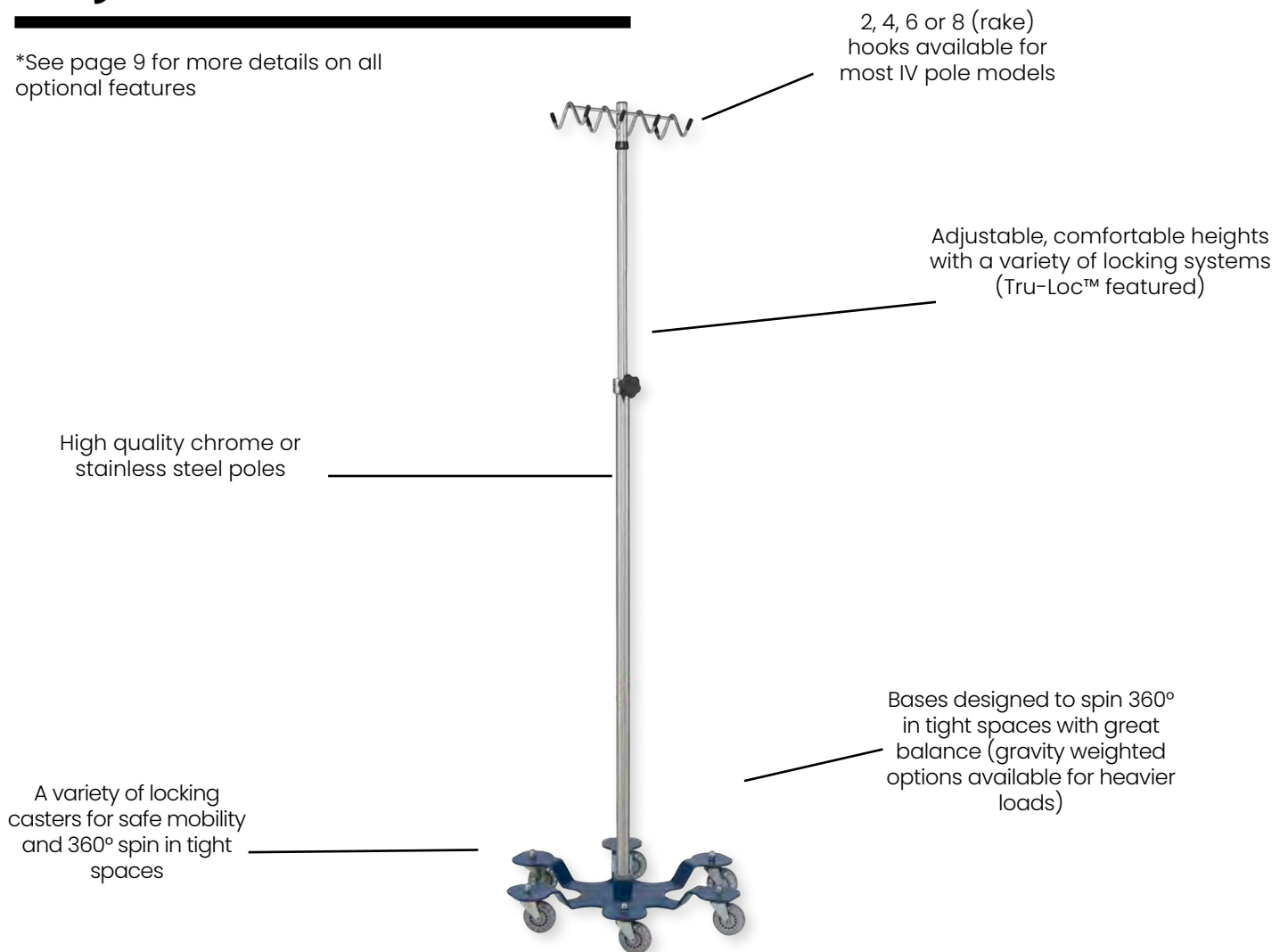

www.blickman.com

IV Stands

4 Leg

4 LEG CHROME IV STANDS

Description: We offer two 4-leg chrome IV stand models, one with a standard base, and one with a heavyweight base. Both base types include Wall Saver™ tips to protect against wall scuff marks. They both move on 2" plastic twin wheel hooded swivel casters and they both come standard with two hooks. A four hook removable adapter is available for model 1305.

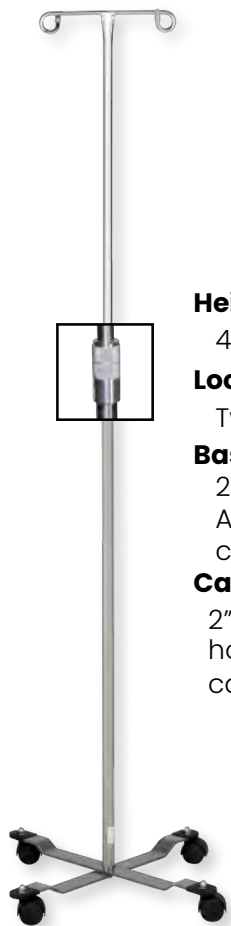

Height adjustment:

47 1/2" - 85 1/2"

Lock:

Twist

Base:

22" diameter
Apoxy coated
chrome

Casters

2" plastic twin wheel
hooded swivel
casters

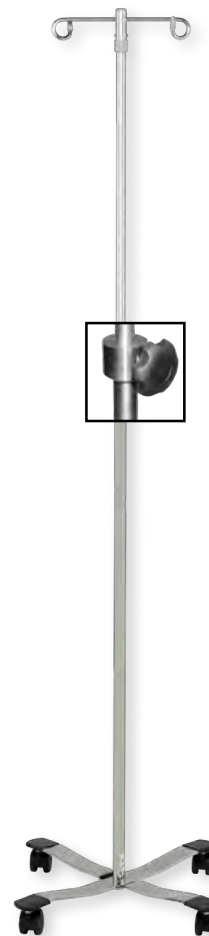

Height adjustment

51 1/2" - 93"

Lock:

Tru-loc™

Base:

22" diameter
Chrome plated
heavy bar steel

Casters

2" plastic twin wheel
hooded swivel
casters

| Name | Standard Base | Heavyweight Base |
|-------------------|-----------------------|--------------------------|
| # of Hooks | 2 Welded Hooks | 2 Removable Hooks |
| Model # | 1305 | 1310 |
| Item # | 0561305000 | 0561310000 |
| Shipping Weight | 13 lbs. | 14 lbs. |

IV Stands

4 Leg

4 LEG STAINLESS STEEL IV STANDS

Description: We offer two types of 4-leg stainless steel IV stands, one with a standard base, and one with a heavyweight base. They come standard with either 2 or 4 removable hooks. Contact customer service for 6- or 8-(rake) hooks.

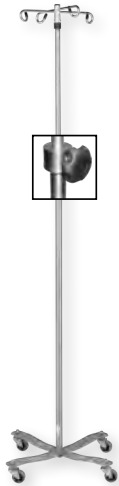

| Name | Standard Base |
|-------------------|----------------|
| # of Hooks | 2 Hooks |
| Model # | 1410SS |
| Item # | 0571410000 |
| Shipping Weight | 13 lbs. |
| # of Hooks | 4 Hooks |
| Model # | 1410SS-4 |
| Item # | 0571410400 |
| Shipping Weight | 14 lbs. |

Height Adjustment: 51 3/4" - 94"
 Mechanism: Tru-Loc™
 Base Material: Stainless steel with Wall Savers™, 22" diameter
 Casters: 2" hard rubber swivel casters

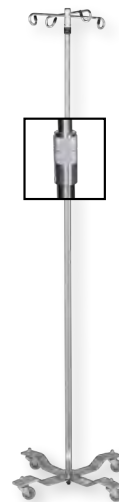
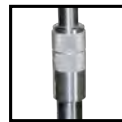

| Name | Heavyweight Base | |
|-------------------|------------------|---------------|
| Lock Type | Twist Lock | Thumb Control |
| # of Hooks | 2 Hooks | |
| Model # | 8890SS | 8889SS |
| Item # | 0528890000 | 0518889000 |
| Shipping Weight | 24 lbs.* | 24 lbs.* |
| # of Hooks | 4 Hooks | |
| Model # | 8890SS-4 | 8889SS-4 |
| Item # | 0528890400 | 0518889400 |
| Shipping Weight | 24 lbs.* | 24 lbs.* |

Height Adjustment: 66" - 100"
 Mechanism: Twist Lock, Thumb Control, Foot Operated
 Base Material: Heavyweight stainless steel flat bar, 22" diameter
 Casters: 2" roller blade swivel casters

*Shipping weight with an asterisk is the combined shipping weight of separate parts

IV Stands

5 Leg

5 LEG IV STANDS

Description: Our 5-leg IV stands come in either chrome (standard & heavy duty) or stainless steel poles and stand on a 24" diameter, polished die cast aluminum base with Wall Saver™ caps. Contact customer service for 6- or 8- (rake) hooks on certain models.



| Name Pole | Chrome Pole | |
|--------------------|-------------------|---------------------|
| | Standard (1") | Heavy Duty (1 1/4") |
| # of Hooks | 2 Hooks | 4 Hooks |
| Caster Heights | 2 1/2" Plastic | 3" Rubber |
| Height Adjustments | 52 1/2" - 93 1/2" | 56" - 100" |
| Model # | 1315-2 | 1350-4 |
| Item # | 0561315000 | 0561350400 |
| Shipping Weight | 16 lbs.* | 17 lbs.* |
| # of Hooks | 4 Hooks | 6 Hooks |
| Caster Heights | 2 1/2" Plastic | 3" Rubber |
| Height Adjustments | 52 1/2" - 93 1/2" | 56" - 100" |
| Model # | 1315-4 | 1350-6 |
| Item # | 0561315400 | 0561350600 |
| Shipping Weight | 16 lbs.* | 17 lbs.* |

Height Adjustment Mechanism: Tru-Loc™
 Base Material: 5 Leg, Polished die cast aluminum, 24" diameter
 Casters: 3" hard rubber OR 2 1/2" twin wheel swivel casters

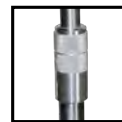

Name

Stainless Steel Pole



| Lock Type | Stainless Steel Pole | | |
|--------------------|----------------------|----------------|---------------|
| | Tru-Loc™ | Twist Lock | Thumb Control |
| # of Hooks | | 2 Hooks | |
| Caster Heights | 2" Rubber | 3" Rubber | 3" Rubber |
| Height Adjustments | 52" - 94" | 74" - 110" | 67" - 98" |
| Model # | 1415SS | 7792SS | 7794SS |
| Item # | 0531415000 | 0537792000 | 0517794000 |
| Shipping Weight | 16 lbs.* | 15 lbs.* | 16 lbs.* |
| # of Hooks | | 4 Hooks | |
| Caster Heights | 2" Rubber | 3" Rubber | 3" Rubber |
| Height Adjustments | 52" - 94" | 74" - 110" | 67" - 98" |
| Model # | 1415SS-4 | 7792SS-4 | 7794SS-4 |
| Item # | 0531415400 | 0537792400 | 0517794400 |
| Shipping Weight | 16 lbs.* | 16 lbs.* | 17 lbs.* |

Height Adjustment Mechanism: Tru-Loc™, Twist Lock, Thumb Control
 Base Material: 5 Leg, Polished die cast aluminum, 24" diameter
 Casters: 2" or 3" hard rubber swivel casters

*Shipping weight with an asterisk is the combined shipping weight of separate parts

IV Stands

6 Leg

6 LEG IV STANDS

Description: Our 6-leg IV stands are designed for hospital applications requiring heavier loads by using low center of gravity bases. They come in either a chrome or a stainless steel pole with a Tru-Loc™ height adjustment mechanism that allows the pole to reach a minimum of 52" high off the ground and a maximum of 90" off the ground. Our 6 leg IV stands come standard with 4-, 6-, and 8-(rake) removable hooks.



Features Include:

- ✓ 23 3/8" diameter base with low center of gravity for improved stability
- ✓ Heavy duty 3" roller blade swivel casters for easy maneuverability
- ✓ Steel powder coated finished base for durability (many colors available)
- ✓ Accommodates up to 4 infusion pumps and up to 8 IV solution bags while preventing tubing line entanglement



Powder Coated Base

Stainless Steel Base

| Name | Chrome Pole | SS Pole | SS Pole |
|-------------------|-----------------------|------------|------------|
| # of Hooks | 4 Hooks | | |
| Model # | 1370-4 | 1370SS-4 | 1371SS-4 |
| Item # | 0561370400 | 0541370400 | 0541371400 |
| Shipping Weight | 29 lbs.* | 29 lbs.* | 26 lbs.* |
| # of Hooks | 6 Hooks | | |
| Model # | 1370-6 | 1370SS-6 | 1371SS-6 |
| Item # | 0561370600 | 0541370600 | 0541371600 |
| Shipping Weight | 29 lbs.* | 29 lbs.* | 26 lbs.* |
| # of Hooks | 8 (rake) Hooks | | |
| Model # | 1370-RH | 1370SS-RH | 1371SS-RH |
| Item # | 0561370RH1 | 05413700RH | 05413710RH |
| Shipping Weight | 29 lbs.* | 29 lbs.* | 26 lbs.* |



*Shipping weight with an asterisk is the combined shipping weight of separate parts

Custom Powder Coated Colors Available Upon Request
Please email us at info@blickman.com

IV Stands

5 Leg

5 LEG WASHABLE IV STAND

Description: Our Hackensack 5-leg IV stand is cart washable - built specifically to withstand high temperatures and cleaning fluids with weep holes in the pole and in the base for fluid drainage. This model comes with a stainless steel pole with a twist lock height adjustment mechanism (74" to 110" inches). It has a 22 7/8" diameter black composite base with twin wheel hooded swivel casters.



| # of Hooks | 2 Hooks |
|-----------------|------------|
| Model # | 7795SS-2 |
| Item # | 0539A02302 |
| Shipping Weight | 16 lbs.* |
| # of Hooks | 4 Hooks |
| Model # | 7795SS-4 |
| Item # | 0539A02304 |
| Shipping Weight | 16 lbs.* |
| # of Hooks | 8 Hooks |
| Model # | 7795SS-RH |
| Item # | 0539A023RH |
| Shipping Weight | 16 lbs.* |



MR CONDITIONAL IV STAND

Description: Our 5 leg MR conditional IV stand consists of a stainless steel pole on a 24" diameter, polished diecast aluminum base with Wall Saver™ caps and 2" MR casters. It is height adjustable from 74" to 110" via a twist lock adjustment mechanism. Choose from either 2- or 4-hooks or contact customer service for 6 or 8 (rake) hooks.

| # of Hooks | 2 Hooks |
|-----------------|------------|
| Model # | 7792MR-2 |
| Item # | 0537792002 |
| Shipping Weight | 16 lbs.* |
| # of Hooks | 4 Hooks |
| Model # | 7792MR-4 |
| Item # | 0537792004 |
| Shipping Weight | 17 lbs.* |

MR Push Handle for MR IV Stands



| Name | Model # | Item # | Ship Weight |
|-------------|---------|------------|-------------|
| Push Handle | 1381MR | 3537426350 | 5 lbs. |

*Shipping weight with an asterisk is the combined shipping weight of separate parts.

IV Stands

Options

IV Hook Configurations



| Part # | Description | Shipping Weight |
|------------|----------------|-----------------|
| 780063700L | 2 hooks | 2 lbs. |
| 780063800L | 4 hooks | 2 lbs. |
| 780066900L | 6 hooks | 2 lbs. |
| 7802808750 | 8 (rake) hooks | 6 lbs. |

Lock Options



Thumb Lock

Tru-Lock™

Twist Lock

Base Options

4 Leg Chrome Bases



Standard



Heavyweight

4 Leg Stainless Steel Bases



Standard



Heavyweight

5 Leg Bases



Standard



Washable

6 Leg Bases



Powder Coated



Stainless Steel

IV Stands

Accessories

IV POLE ATTACHMENTS



Wire Basket

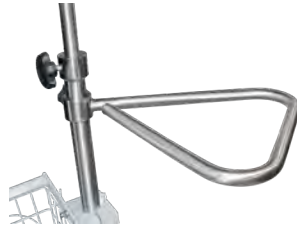

Guidance Handle



Power Strip



Accessory Clamp



Drainage Bag Hook



Pump Support Tray



Multi-pump Support



Tank holder

| Part # | Description | Shipping Weight |
|------------|---------------------------------------|-----------------|
| 3501389001 | Wire Basket | 9 lbs. |
| 3501381000 | Guidance Handle (MR Option Available) | 4 lbs. |
| 9101107600 | Power Strip | 4 lbs. |
| 7801380000 | Accessory Clamp | 4 lbs. |
| 7801382000 | Drainage Bag Hook | 1 lbs. |
| 7801384000 | Pump Support Tray | 2 lbs. |
| 7801385000 | Multi-pump Support | 2 lbs. |
| 7801386000 | Tank Holder | 5 lbs. |

IV Stands

Construction Specifications

Construction Specifications

| | |
|----------------------|--|
| Universal Dimensions | Height Range: 47" - 110" Base Diameter Range: 22" - 24" |
| Materials | 304 stainless steel Chrome |
| Gauge | Stainless Steel IV Stands: Base Pole: 1" Diameter, 16GA; Extension Pole: ¾" Diameter, 18GA Exception: 1370/1371 series Base Pole: 1 ¼" Diameter, 16 GA; Extension Pole: 1" Diameter, 18GA |
| Welding | All welding by heliarc method and exposed welds are ground smooth |
| Finish | Exposed surfaces are free from pit marks, weld seams, scale and are polished with #4 polish to a satin finish |
| Casters | See page 9 |
| Notes | MR conditional IV stand option available where indicated |

Shipping Information

All shipping weights are estimates and may be changed without prior notice. Specifications may be improved and dimensions changed without prior notice. Please contact customer service for estimated shipping costs at info@blickman.com.

Note for: *IV Stands* Parts shipped separately to avoid damage and lower costs. Shipping weight with an asterisk is the combined shipping weight of separate parts. Some assembly required.

THE BLICKMAN DIFFERENCE

IV Irrigation Safety Systems

- Our IV Irrigation Safety Systems (IVTs) offer superior safety, efficiency, and financial value for fluid intensive IV irrigation procedures, such as arthroscopic, hysteroscopic, endoscopic, TURP, etc.
- They maintain continuous fluid delivery by offering infinitely adjustable heights for up to eight 3 liter or 5 liter IV bags on four independent channels.
- Their easy, one handed operation allows nurses to attach IV bags at comfortable heights, starting at 5 ft., and then raise bags up to 8 ft. (or to 9 ft. with custom extender) simply by pushing down on "squeeze/release" handles, an ergonomic solution that meets OSHA standards and greatly reduces the threat of back injuries.

Key Product Features

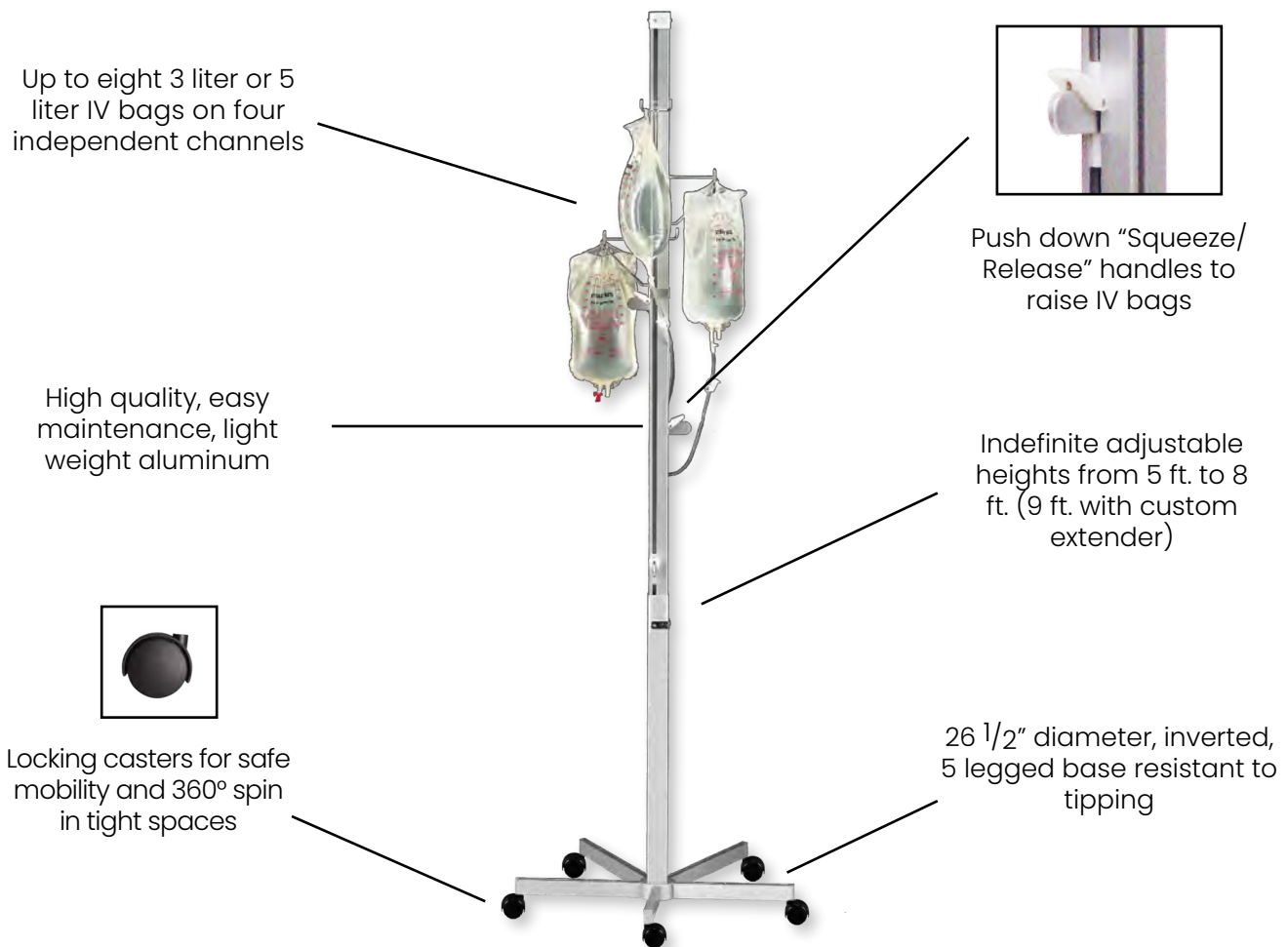

WHY CHOOSE OUR IVT?



Safe:

- This ergonomic solution meets OSHA standards and greatly reduces the threat of back injuries with its one-handed operation which allows nurses to attach IV bags at comfortable heights, simply by pushing down on “squeeze/release” handles, an
- Hard anodized aluminum construction with stain resistant finishes makes it so that no surfaces can chip, flake, or rust to introduce particle matter into a sterile or surgical environment.
- The lowest positions are cushioned by shock absorbers, thus sparing the common banging known to occur with the standard IV poles, which results in tearing of bag tabs and spilling remaining fluids onto the O.R. floor.
- The steady, five-legged bases resist potential tipping hazards, eliminating the need for “sand bagging”.

Efficient:

- There are no electrical aspects that require overnight charging, so they are always ready, whenever you are ready.
- The ability to stagger heights of up to eight 3 liter or 5 liter bags ensures continuous flow of liquids, as it allows you to change an IV bag, while the other bags are still irrigating.
- Easy to clean and maintain
- Compact footprint frees up valuable space on the O.R. floor.

Affordable:

- Our IV Irrigation systems are value leaders among a few comparable models, saving you up to **\$50/procedure** on IV tubes vs. those required with far more expensive, pump driven systems.

Irrigation Systems

IVTs

Description: We offer two types of IVTs, one with 2 hooks, which holds up to 4 IV bags and one with 4 hooks, which holds up to 8 IV bags. Hooks can raise and lower from 67" to 81". They travel on black plastic twin wheel hooded swivel casters. Both IVTs come with 26 1/2" diameter inverted, 5 leg base.

Our IVT stands have the same dimensions:

Width: 12 3/4" x Height: 89" x Depth: 12 3/4"

Note: these dimensions do not include the base



| Name | IVT 2 Channels | IVT 4 Channels |
|-----------------|----------------|----------------|
| Item # | IVT-2 | IVT-4 |
| Model # | 0541110200 | 0541110100 |
| Shipping Weight | 85 lbs.* | 85 lbs.* |

For Custom Extender

Please email us at info@blickman.com

*Shipping weight with an asterisk is the combined shipping weight of separate parts

Irrigation Systems

Construction Specifications

Construction Specifications

Universal Dimensions Tower: Width: 12 3/4" x Height: 89" x Depth: 12 3/4"
Base Diameter: 26 1/2"
Height Range of Hooks: 67" - 81"

Materials Hard anodized aluminum

Gauge N/A

Welding N/A

Finish Stain resistant finishes

Casters 2" black plastic, twin wheel, hooded swivel casters

Notes

Shipping Information

All shipping weights are estimates and may be changed without prior notice. Specifications may be improved and dimensions changed without prior notice. Please contact customer service for estimated shipping costs at info@blickman.com.

Note for: Parts shipped separately to avoid damage and lower costs.
IV Stands Some assembly required.

BLICKMAN



Mayo Stands

Maximum utility in minimal space

Includes:

- Chrome Mayo stands
- Stainless steel Mayo stands



THE BLICKMAN DIFFERENCE

- Our Mayo stands have evolved to meet the needs of the marketplace for maximum utility in an increasingly crowded surgical environment.
- We have an array of options with varying material, bases, shapes, and adjustment mechanisms to suit your needs.
- All of our Mayo stands are mobile and use 2" roller blade, hard rubber, or twin wheel plastic hooded casters.

Key Product Features

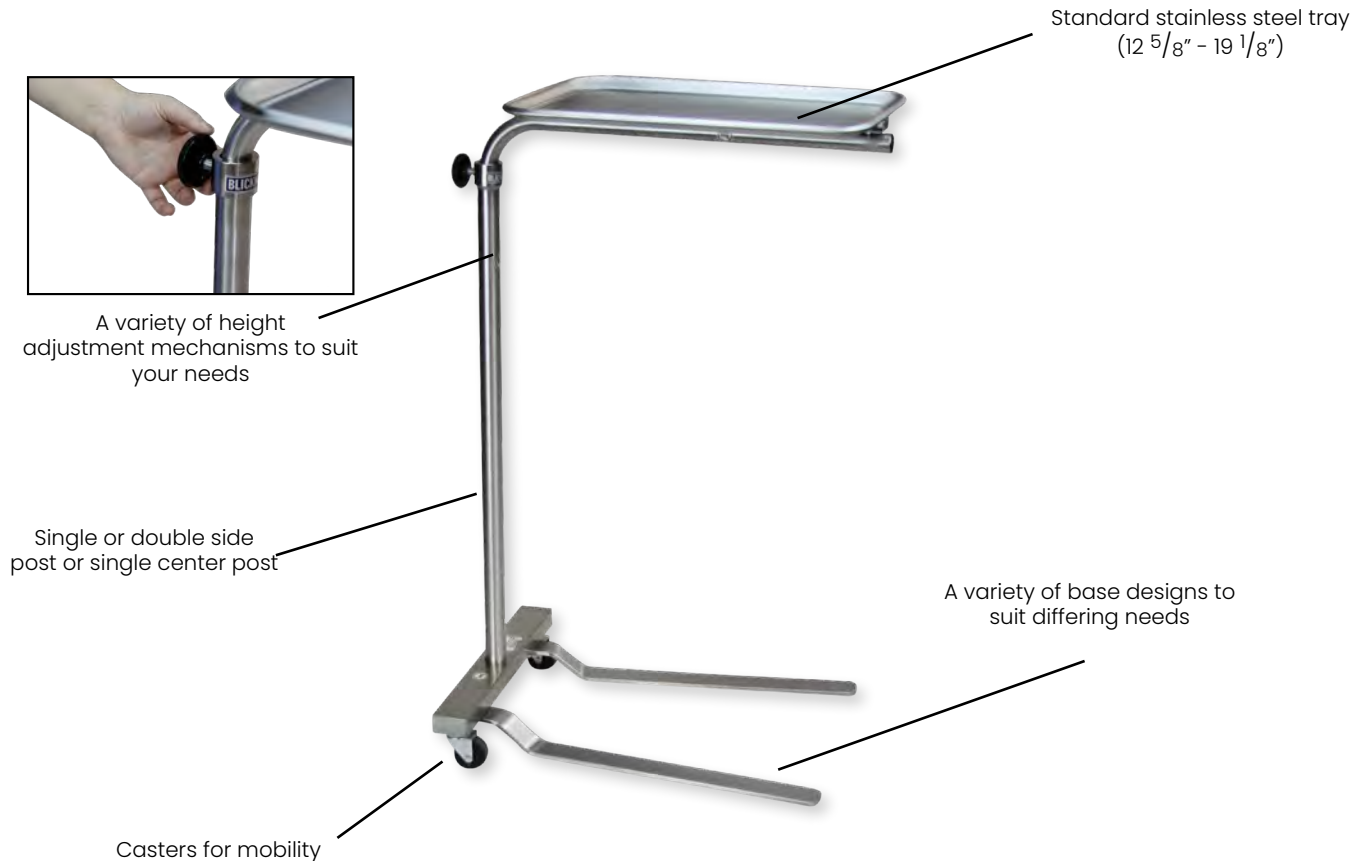

2" Rollerblade Casters



2" Hard Rubber Casters



2" Twin Wheel Hooded Casters

Mayo Stands

Chrome

CHROME MAYO STANDS

Description: Each of our chrome Mayo stands contain a 12 ¹/₈" x 19 ¹/₈" stainless steel tray and are height adjustable using the Tru-Loc™ friction knob. We offer different base and pole set ups to meet your varying needs.

Middle Pole

Base: Five leg cast aluminum base with wall savers™ and 2" twin wheel hooded casters



Double Pole

Base: Chrome loop base with two 2" twin wheel hooded back casters



Single Pole

Base: Two pronged chrome base with single hard rubber back casters



| Name | Middle Pole | Double Pole | Single Pole |
|-------------------|--|--|--|
| Height Adjustment | 29 ¹ / ₂ " - 49" | 34 ¹ / ₂ " - 54" | 34 ¹ / ₂ " - 54" |
| Model # | 1501 | 1510 | 1515 |
| Item # | 0661501000 | 0661510000 | 0661515000 |
| Shipping Weight | 14 lbs. | 18 lbs. | 12 lbs. |

Mayo Stands Stainless Steel

NEWARK MAYO STANDS

Description: Each of our stainless steel Mayo stands contain a 12 1/8" x 19 1/8" stainless steel tray and are height adjustable using the Tru-Loc™ friction knob. We offer different base set ups to meet your varying needs.

Lightweight

Base: Two pronged stainless steel base with two hard rubber back casters



Standard



Base: Two pronged stainless steel base with two roller blade back casters



Four Caster

Base: Two pronged stainless steel base with four roller blade casters



| Name | Lightweight |  Standard |  Four Caster |
|-------------------|---------------|--|---|
| Height Adjustment | 37 1/4" - 64" | 39 1/2" - 62" | 39 1/2" - 62" |
| Model # | 1520SS | 8841SS | 8841MR |
| Item # | 0671520000 | 0638841000 | 0638841200 |
| Shipping Weight | 26 lbs. | 36 lbs. | 36 lbs. |



Mayo Stands Stainless Steel

BENJAMIN MAYO STAND

Description: Our Benjamin Mayo stand design is made for ease and durability. Our state of the art double post design minimizes lateral movement and increases overall stability. We offer this design in three different tray sizes.



Via a foot operated mechanism, you can adjust the height from 39 1/2" to 62" high off the ground. A guard over the foot prevents accidental release.

| Name | Benjamin Mayo Stands | |
|------------------|-------------------------------------|---|
| Tray Size | 12 5/8" x 19 1/8" (Standard) |  |
| Model # | 8867SS | |
| Item # | 0668867000 | |
| Shipping Weight | 40 lbs. | |
| Tray Size | 16" x 21" |  |
| Model # | 8869SS | |
| Item # | 0668869000 | |
| Shipping Weight | 41 lbs. | |
| Tray Size | 20" x 25" |  |
| Model # | 8871SS | |
| Item # | 0668871000 | |
| Shipping Weight | 43 lbs. | |

Mayo Stands

Construction Specifications

Construction Specifications

| | |
|----------------------|---|
| Universal Dimensions | Standard Tray Size: Width: 12 5/8" x Depth: 19 1/8" |
| Materials | 304 stainless steel Chrome |
| Gauge | All contain stainless steel trays: 20GA Benjamin Mayo Stands: 3/4" diameter, 18GA tubes, 1/8" base Newark Mayo Stands: 1520SS: 1 1/4" diameter, 18GA tube, weighted base 8841SS/8848SS: 1" diameter, 16GA tube, 3/8" base |
| Welding | All welding by heliarc method and exposed welds are ground smooth |
| Finish | Exposed surfaces are free from pit marks, weld seams, scale and are polished with #4 polish to a satin finish |
| Casters | 2" plastic hooded twin wheel, hard rubber, or roller blade casters |
| Notes | MR conditional Mayo stands available where indicated |

Shipping Information

All shipping weights are estimates and may be changed without prior notice. Specifications may be improved and dimensions changed without prior notice. Please contact customer service for estimated shipping costs at info@blickman.com.

BLICKMAN



Scrub Sinks

Hands free multi-station operation

Includes:

- Windsor Scrub Sinks
- Lodi Scrub Sinks
- Accessories



THE BLICKMAN DIFFERENCE

Scrub Sinks

- Our two scrub sink models, the Windsor and the Lodi, are each available with single, dual, and triple stations. A four-station unit is also available in the Windsor model.
- They have deep sink bowls with sound-deadened enclosed double walled panels that are angled in to divert water splashes along with spouts positioned toward the rear of the sink. Standard gooseneck faucets included.
- All operation options are hands free. The Lodi scrub sinks have infrared water control and knee-action water and soap dispensers, and the Windsor scrub sinks come standard with knee-action control, but they are also available in foot, elbow, and infrared sensor controls.

Key Product Features

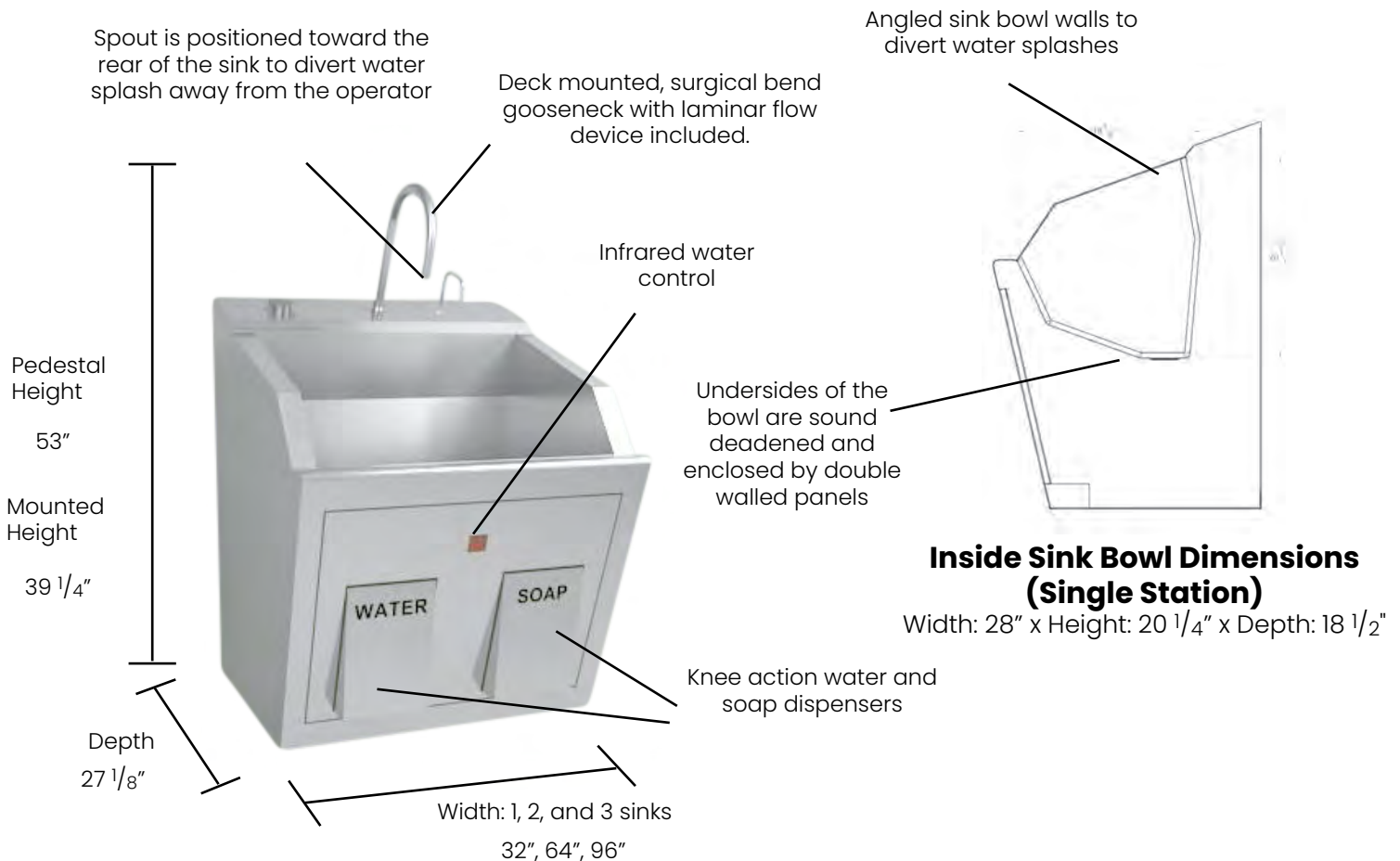

Scrub Sinks

Windsor

WINDSOR SCRUB SINKS

Description: Our Windsor scrub sinks are all wall mounted and utilize one undivided sink bowl. Choose from our four different hands free operations: knee, foot, elbow, or infrared. Standard gooseneck faucets included.

Inside Sink Bowl Dimensions

Width: 21 3/4" x Height: 8" x Depth: 14 1/2"



Width
25"



Width
47"



Width
69"



Width
91"

| Name | 1 Station | 2 Stations | 3 Stations | 4 Stations |
|---------------------|------------|------------|------------|------------|
| Knee Action | | | | |
| Model # | 7878SS-KA | 7879SS-KA | 7880SS-KA | 7881SS-KA |
| Item # | 1317878000 | 1317879000 | 1317880000 | 1317881000 |
| Shipping Weight | 65 lbs. | 145 lbs. | 190 lbs. | 305 lbs. |
| Foot Action | | | | |
| Model # | 7878SS-FO | 7879SS-FO | 7880SS-FO | 7881SS-FO |
| Item # | 1317878003 | 1317879003 | 1317880003 | 1317881003 |
| Shipping Weight | 65 lbs. | 145 lbs. | 190 lbs. | 305 lbs. |
| Elbow Action | | | | |
| Model # | 7878SS-EA | 7879SS-EA | 7880SS-EA | 7881SS-EA |
| Item # | 1317878004 | 1317879004 | 1317880004 | 1317881004 |
| Shipping Weight | 65 lbs. | 145 lbs. | 190 lbs. | 305 lbs. |
| Infrared | | | | |
| Model # | 7878SS-IF | 7879SS-IF | 7880SS-IF | 7881SS-IF |
| Item # | 1317878001 | 1317879001 | 1317880001 | 1317881001 |
| Shipping Weight | 65 lbs. | 145 lbs. | 190 lbs. | 305 lbs. |

Scrub Sinks

Lodi

LODI SCRUB SINKS

Description: Our Lodi scrub sinks come standard with both infrared water control and knee-action water and soap dispensers. All units are available in either pedestal or wall-mounted configurations. Standard gooseneck faucets included.



Width
32"



Width
64"



Width
96"



Height
53"



Height
39 1/4"

| Name | 1 Station | 2 Stations | 3 Stations |
|---------------------|------------|------------|------------|
| Pedestal | | | |
| Model # | 988ISSP | 9882SSP | 9883SSP |
| Item # | 1339881P00 | 1339882P00 | 1339883P00 |
| Shipping Weight | 275 lbs. | 420 lbs. | 600 lbs. |
| Wall Mounted | | | |
| Model # | 988ISSW | 9882SSW | 9883SSW |
| Item # | 1339881W00 | 1339882W00 | 1339883W00 |
| Shipping Weight | 215 lbs. | 360 lbs. | 570 lbs. |

Scrub Sinks

Accessories

LODI SCRUB SINK ACCESSORIES

- Factory Installed Options -



Digital Timer



Eyewash

- For Wall Mount Installation -



Chair Carrier
For Wall Mount Installation

| # of Stations | One | Two | Three |
|-----------------|------------|------------|------------|
| Part # | 4301224751 | 4301224752 | 4301224753 |
| Shipping Weight | 47 lbs. | 119 lbs. | 141 lbs. |

Scrub Sinks

Construction Specifications

Construction Specifications

Standard Dimensions **Lodi:** (W) 32", 64", 96" x (D) 27 1/4" x (H): 39 1/4", 53"
Internal Sink (Single Station): 28" x 18 1/2" x 20 1/4"
Windsor: (W) 25", 47", 69", 91" x (D) 18 1/2" x (H): 15 3/4"
Internal Sink: 21 3/4" x 8" x 14 1/2"

Materials/
Gauge 304 stainless steel
Lodi: Mix of 16GA and 14GA
Windsor: 16 GA
Double/Triple Station Lodi Scrub Sinks: Plastic Dividers

Welding All welding by heliarc method and exposed welds are ground smooth

Finish Exposed surfaces are free from pit marks, weld seams, scale and are polished with #4 polish to a satin finish

Electrical Available in standard 100/120 VAC input or 220/240 VAC
Units are FDA registered and conform to standards for Safety Medical Electrical Equipment UL 606011 (US) and CSA C22.2 #601.1M90 (Canada)
Units are cord connected with a hospital grade cap

Casters N/A

Shipping Information

All shipping weights are estimates and may be changed without prior notice. Specifications may be improved and dimensions changed without prior notice. Please contact customer service for estimated shipping costs at info@blickman.com.

BLICKMAN



Solution Stands/ Receptacles

Roll, collect, dispose

Includes:

- Solution Stands
- Kickbucket
- Receptacle



THE BLICKMAN DIFFERENCE

- Our high quality, heavy-gauge, noise-reducing, solution stands and receptacles ensure your solutions and waste products are easily collected and disposed of in these easy-to-move, easy-to-clean product.
- Our solution stands and receptacles move effortlessly and quietly on 2" swivel casters, and are made out of our high-quality, easy-to-clean 304 stainless steel with MR conditional options available for both.
- Our solution stands are 33" high for compatibility with surgical table heights and are in the safe zone for reduced back stress, and our receptacles are low to the floor to pass under surgical tables and make it easy to drop waste into without reaching around the table.
- Our basins and pails are removable for both the solution stands and receptacles that are held in place by rubber bumpers that also help prevent noise from metal on metal contact.

Key Product Features



Solution Stands

Description: We offer two types of stainless steel solution stands: a single basin model and a double basin model. Our solution stands are 33" tall offering compatibility with surgical table heights and are in the safe zone for reduced back stress. Choose between a lower shelf or an H-brace for added storage and support. MR conditional models available.







Dimensions:

Width: 15" x Height: 33" x Depth: 15"



Dimensions:

Width: 29" x Height: 33" x Depth: 15"

| Name | Single Basin Solution Stand | | Double Basin Solution Stand | |
|--|---|---|-----------------------------|---|
| |  |  | Shelf |  |
|  | Model # | 7807SS | 7807MR | 7808SS |
| | Item # | 0717807000 | 0717807066 | 0727808000 |
| | Shipping Weight | 20 lbs. | 20 lbs. | 33 lbs. |
| | | | | |
| | | | H-Brace | |
|  | Model # | 7807SS-HB | 7807MR-HB | 7808SS-HB |
| | Item # | 0717807100 | 0717807166 | 0727808100 |
| | Shipping Weight | 19 lbs. | 19 lbs. | 24 lbs. |

Solution Basin Also Sold Separately



| Name | Model # | Item # | Ship Weight |
|-----------------------------|---------|------------|-------------|
| 8.5 qt. Solution Basin Only | SB-1 | 9737370120 | 3 lbs. |

Receptacles

Description: Our stainless steel kickbucket consists of a continuous encircling rubber bumper, which helps prevent tipping, wall scuff marks, and noise. A stainless steel cross brace provides excellent protection, securely holds a heavy gauge 13 qt. pail, as well as roller blade casters for mobility.

Parts Also Sold Separately

Parts Also Sold Separately



#KB-1



#7766NP



#SB-1



#8766NP



Kickbucket

13 qt. Pail

Receptacle

8.5 qt. Solution Basin

KICKBUCKET

| Name | Model # | Item # | Ship Weight |
|--|---------|------------|-------------|
| Lenox Kickbucket with Pail  | 7766SS | 0817766000 | 12 lbs. |
| Lenox Kickbucket with Pail  | 7766MR | 0817766066 | 12 lbs. |

ORDER SEPARATELY

| | | | |
|-----------------------------|--------|------------|--------|
| Lenox Kickbucket Frame Only | 7766NP | 0817766001 | 9 lbs. |
| 13 qt. Pail Only | KB-1 | 9701920000 | 4 lbs. |

RECEPTACLE

| Name | Model # | Item # | Ship Weight |
|------------------------------|---------|------------|-------------|
| Sponge Receptacle with Basin | 8766SS | 0828766000 | 11 lbs. |

ORDER SEPARATELY

| | | | |
|------------------------------|--------|------------|--------|
| Sponge Receptacle Frame Only | 8766NP | 0828766001 | 9 lbs. |
| 8.5 qt. Solution Basin Only | SB-1 | 9737370120 | 3 lbs. |



Solution Stands

Construction Specifications

Construction Specifications

| | |
|----------------------|---|
| Universal Dimensions | Solution Stands: 15", 29" x 33" x 15" Solution Basin: 8.5 qts. Pail: 13 qts. |
| Materials | 304 stainless steel |
| Gauge | Solution Stand Frame: 1" diameter tube, 16GA Solution Stand Shelf: 20GA Pail: 22GA; Basin: 14GA |
| Welding | All welding by heliarc method and exposed welds are ground smooth |
| Finish | Exposed surfaces are free from pit marks, weld seams, scale and are polished with #4 polish to a satin finish |
| Casters | 2" swivel casters |
| Notes | MR conditional options available where indicated |

Shipping Information

All shipping weights are estimates and may be changed without prior notice. Specifications may be improved and dimensions changed without prior notice. Please contact customer service for estimated shipping costs at info@blickman.com.

BLICKMAN



Surgical Utensils

Safe, sterile, stainless steel

Includes:

- Dressing Jars
- Emesis Basins
- Ointment Jars
- Bucket Pail
- Solution Basins
- Instrument Trays
- Catheter Tray
- Iodine Cups
- Medicine Cup
- Graduated Measuring Cups



THE BLICKMAN DIFFERENCE

- We offer a comprehensive range of surgical utensils to complement the high-end quality of our hospital equipment.
- We offer utensils that function to hold other surgical materials and liquids of various types.
- All utensils are stainless steel and welded smooth to ensure sterility for surgery.
- Our measuring utensils have units of measurement commonly used in the medical industry etched inside.

Key Product Features



Surgical Utensils

Description: Our surgical utensils are solid stainless steel and are great for sterile use in the OR.



Dressing Jars
DJ1-7



Emesis Basins
EB1-4



Ointment Jar
OJ-1

| Model # | Item # | Capacity/Dimensions | Shipping Weight |
|----------------------|------------|---------------------|-----------------|
| Dressing Jars | | | |
| DJ-1 | 9788000001 | 0.5 liters | 1 lbs. |
| DJ-2 | 9788010002 | 1.0 liters | 1 lbs. |
| DJ-3 | 9788020003 | 1.9 liters | 2 lbs. |
| DJ-4 | 9788030004 | 2.8 liters | 2 lbs. |
| DJ-5 | 9788040005 | 4.0 liters | 2 lbs. |
| DJ-6 | 9788060006 | 5.7 liters | 2 lbs. |
| DJ-7 | 9788080007 | 7.6 liters | 3 lbs. |
| Emesis Basins | | | |
| EB-1 | 9717090400 | 12 oz. | 1 lbs. |
| EB-2 | 9720595450 | 16 oz. | 1 lbs. |
| EB-3 | 9725511555 | 28 oz. | 1 lbs. |
| EB-4 | 9730514065 | 56 oz. | 1 lbs. |
| Ointment Jar | | | |
| OJ-1 | 9787720001 | 8 oz. | 1 lbs. |



Bucket Pail
KB-1



Solution Basins
SB-1

| Model # | Item # | Capacity/Dimensions | Shipping Weight |
|-----------------------|------------|---------------------|-----------------|
| Bucket Pail | | | |
| KB-1 | 9701920000 | 12.3 liters | 4 lbs. |
| Solution Basin | | | |
| SB-1 | 9737370120 | 8 liters | 3 lbs. |
| 1830 | 9701830000 | 6.5 liters | 2 lbs. |

Surgical Utensils

Description: Our surgical utensils are solid stainless steel and are great for sterile use in the OR.



Instrument Trays
IT1015-2520



Catheter Tray
CT1, IT, IC

| Model # | Item # | Capacity/Dimensions | Shipping Weight |
|-------------------------|------------|----------------------------|-----------------|
| Instrument Trays | | | |
| IT1015 | 9710015001 | 15" W x 10" D | 3 lbs. |
| IT1621 | 9716002100 | 21" W x 16" D | 4 lbs. |
| IT1525 | 3603915250 | 25" W x 16" D | 5 lbs. |
| IT2025 | 3603920251 | 25" W x 20" D | 6 lbs. |
| IT1219 | 9719126250 | 19" W x 12 1/2" D | 4 lbs. |
| IT2520 | 9736392025 | 20" W x 25" D | 6 lbs. |
| Catheter Tray | | | |
| CT-1 | 9785030101 | 8 1/2" W x 3" D x 1 1/2" H | 1 lbs. |
| CT-IT | 9782831000 | 8 1/2" W x 3" D x 1" H | 1 lbs. |
| CT-IC | 9782832000 | 8 1/2" W x 3" D x 1 1/2" H | 1 lbs. |



Iodine Cups
IC1-2



Medicine Cup
MC-1



Graduated
Measuring Cups
GM1-3

| Model # | Item # | Capacity/Dimensions | Shipping Weight |
|---------------------------------|------------|---------------------|-----------------|
| Iodine Cups | | | |
| IC-1 | 9775500002 | 6 oz. | 1 lbs. |
| IC-2 | 9710565001 | 14 oz. | 1 lbs. |
| Medicine Cup | | | |
| MC-1 | 9784920001 | 2 oz. | 1 lbs. |
| Graduated Measuring Cups | | | |
| GM-1 | 9795160001 | 16 oz. | 1 lbs. |
| GM-2 | 9795320002 | 32 oz. | 1 lbs. |
| GM-3 | 9795640003 | 64 oz. | 1 lbs. |



Surgical Utensils

Construction Specifications

Construction Specifications

| | |
|---------------------|--|
| Standard Dimensions | N/A |
| Material | 304 stainless steel |
| Gauge | 20GA: Graduated Measuring Cup, Instrument trays (exception 15"x10" Instrument Tray is 24GA) 22GA: Dressing Jars, Emesis Basins, Ointment Jar, Bucket Pail, Solution Basin, Catheter Tray and Cover, Iodine Cups, Graduated Measuring Cups |
| Welding | All welding by heliarc method and exposed welds are ground smooth |
| Finish | Exposed surfaces are free from pit marks, weld seams, scale and are polished with #4 polish to a satin finish |
| Casters | N/A |

Shipping Information

All shipping weights are estimates and may be changed without prior notice. Specifications may be improved and dimensions changed without prior notice. Please contact customer service for estimated shipping costs at info@blickman.com.

BLICKMAN



Tables

Adaptable work and prep surfaces

Includes:

- Instrument Tables
- Utility Tables
- Work Tables



THE BLICKMAN DIFFERENCE

Adjustable Tables

- Our adjustable tables are instrument tables designed to straddle the OR table using either manual or motorized adjustable height mechanisms to accommodate changes in the table position during neuro, cardiac, and orthopedic surgery, as well as varying heights of personnel during general surgery.
- You can customize the tabletop dimensions to fit your differing surface area needs and the leg clearance dimensions to fit your differing OR table dimensions.
- Models are made out of stainless steel and include casters for mobility.
- The motorized table moves along telescoping aluminum lifting columns.

Key Product Features

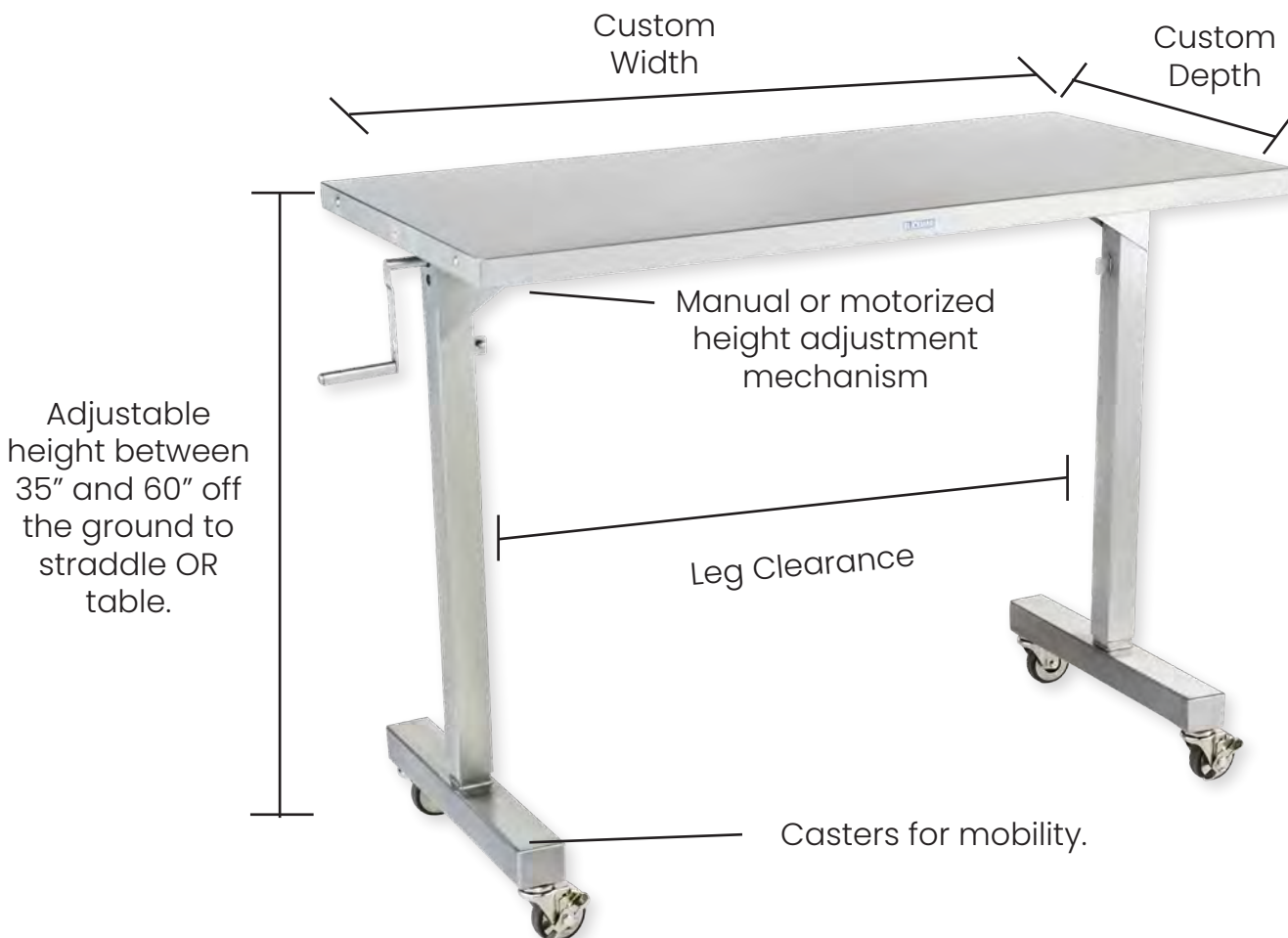

Tables

Adjustable Tables

BACK TABLE

Description: Our specialty back table is designed to provide additional room for extensive surgeries which require a wide array of equipment and instruments. Height adjustment from 46-49" is achievable with either pneumatic assist or manually. The top tier 'hide-away' shelf is angled for easier instrument viewing and holds multiple trays. Tables have sanitary closed tops which help prevent bacterial build up. Sealed reinforcing channels provide rigidity and durability.

Performance Back Table



Manual Back Table



Pneumatic Assist

| Model # | Item # | Description | Length | Depth | Height | Overall Adjustable Height | Shipping Weight |
|---------|------------|--|--------|-------|--------|---------------------------|-----------------|
| BT4830 | 0364830340 | Back Table with 3" Overshelf | 48" | 30" | 34" | 46-49" | 250 lbs. |
| BT6030 | 0366030340 | Back Table with 3" Overshelf | 60" | 30" | 34" | 46-49" | 298 lbs. |
| BTP6030 | 036603034P | Back Table Performance with 3" Overshelf | 60" | 30" | 34" | 46-49" | 360 lbs. |
| BT7230 | 0367230340 | Back Table with 3" Overshelf | 72" | 30" | 34" | 46-49" | 345 lbs. |
| BTP7230 | 036723034P | Back Table Performance with 3" Overshelf | 72" | 30" | 34" | 46-49" | 413 lbs. |

**All models come standard with 3" casters.*

Custom Dimensions Available Upon Request

Please email us at info@blickman.com

Tables

Adjustable Tables

THE LIBERTY TABLE

Description: Our Liberty table was designed to straddle the OR table with adjustable height mechanisms. It travels effortlessly on antistatic swivel casters with brakes and utilizes a motorized height adjustment mechanism. Use a foot pedal or hand remote to operate the motorized adjustment. Two standard surface areas available.

Customize the surface area dimensions to fit your needs.

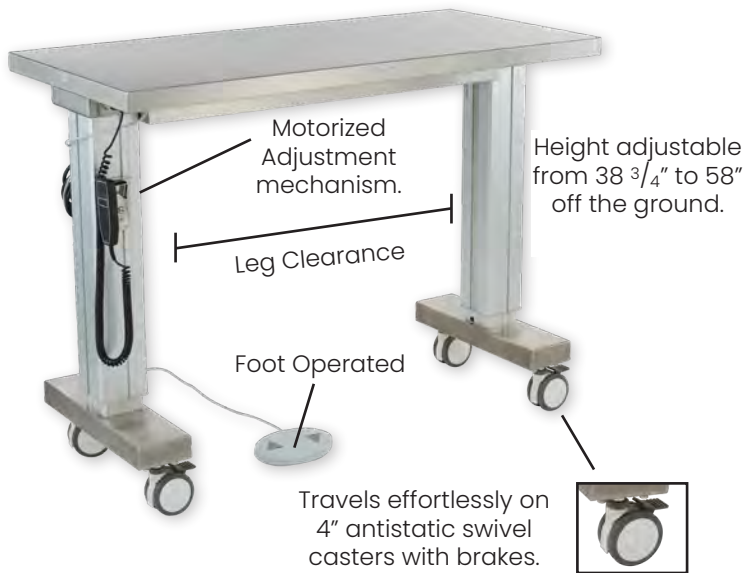

Standard Features

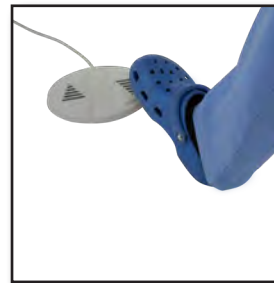

Foot Pedal



Hand Remote

MOTORIZED ADJUSTMENT:

Use the motorized foot operated/hand operated height adjustment mechanism.

| Model # | Item # | Description | Width | Depth | Clearance | Shipping Weight |
|----------|------------|---|---------|-------|-----------|-----------------|
| 7902SS-M | 0157902000 | Liberty Table with Adjustable Height 38 3/4-58" | 41" | 46" | 29" | 315 lbs. |
| 7901SS-M | 0157901000 | Liberty Table with Adjustable Height 38 3/4-58" | 50 1/2" | 24" | 38 3/8" | 290 lbs. |

Custom Dimensions Available Upon Request

Please email us at info@blickman.com

Tables

Adjustable Tables

HYDRAULIC INSTRUMENT TABLE

Description: Our hydraulic instrument table is height adjustable to ensure compatibility with multiple OR table heights and healthcare personnel heights. Adjust its height with a manual hand crank from 30" - 42". It includes one lower shelf and stands stationary on glider feet tips. Select the surface area with dimensions that fit your needs.

Customize the surface area dimensions to fit your needs.



| Model # | Item # | Description | Length | Width | Shipping Weight |
|---------|------------|---|--------|-------|-----------------|
| 7835HYD | 0177835000 | Hydraulic Table with Adjustable Height 30-42" | 48" | 24" | 145 lbs. |
| 7836HYD | 0177836030 | Hydraulic Table with Adjustable Height 30-42" | 60" | 30" | 188 lbs. |

Custom Dimensions Available Upon Request
Please email us at info@blickman.com

Tables

Adjustable Tables

THE GEORGETOWN TABLE

Description: Our Georgetown table was designed to straddle the OR table with a manual hand crank adjustable height mechanism. Height adjustment within ergonomic range between 36" and 56" off the ground. Travels easily on 3" swivel casters with breaks. Two standard surface areas available. Select extended arm design for electrophysiology procedures.

Customize the surface area dimensions to fit your needs.

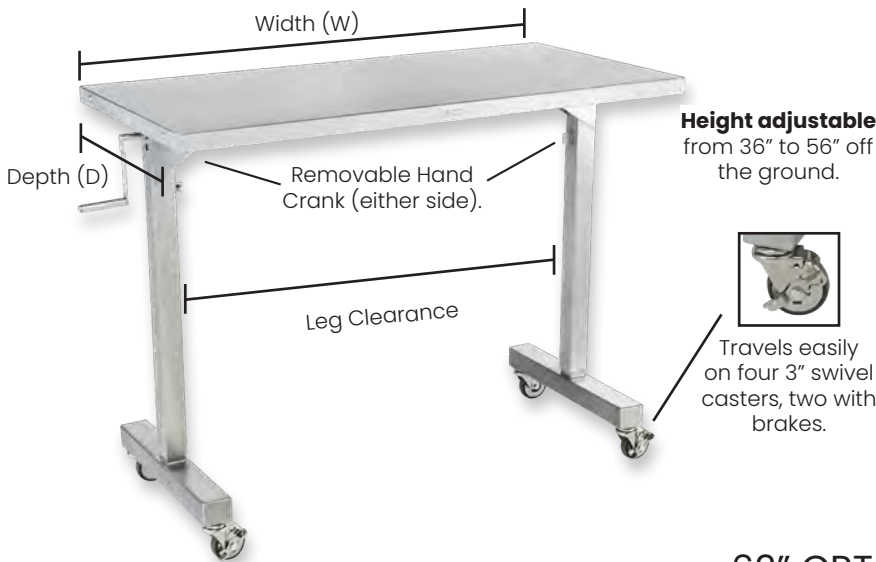

Height adjustable
from 36" to 56" off
the ground.



Travels easily
on four 3" swivel
casters, two with
brakes.

Standard Features



Hand Crank

MANUAL ADJUSTMENT:
Manually adjust the height of this table from
either side with a detachable crank handle.

62" CRT table

This Georgetown table with the
14" extended arm was designed for
optimizing electrophysiology
procedures.

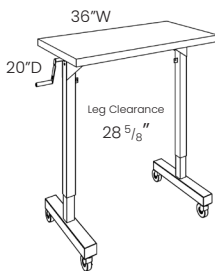

7892SS-0

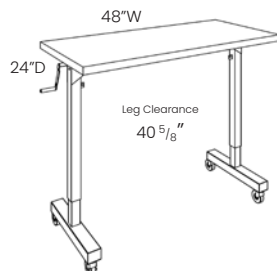

7895SS-0

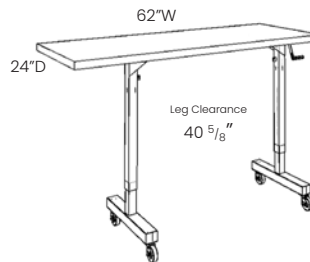

7895SS-0 CRT

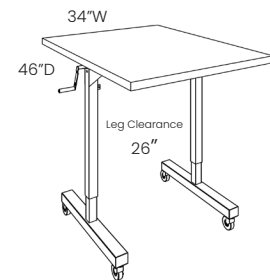

7896SS-0

Name

Georgetown Table

| Model # | Item # | Width | Depth | Leg Clearance | Shipping Weight |
|--------------|------------|-------|-------|---------------|-----------------|
| 7892SS-0 | 0157892000 | 36" | 20" | 28 5/8" | 135 lbs. |
| 7895SS-0 | 0157895000 | 48" | 24" | 40 5/8" | 160 lbs. |
| 7895SS-0 CRT | 0157895062 | 62" | 24" | 40" | 190 lbs. |
| 7896SS-0 | 0157896000 | 34" | 46" | 26" | 175 lbs. |

Custom Dimensions Available Upon Request

Please email us at info@blickman.com

Tables

Adjustable Tables

OVERBED TABLE

Description: Our overbed table comes in an attractive mark resistant laminate top in a walnut wood grain. It moves up or down with a simple one touch adjustment. Security features include a built-in column lock and four point base. The table travels smoothly on four 2" hooded casters.

Overbed Table Dimensions

Width: 30" x Height: 30" (max) x Depth: 15 1/2"



| Model # | Item # | Description | Width | Depth | Height | Shipping Weight |
|---------|------------|---------------|-------|---------|---------|-----------------|
| 3400 | 2833400000 | Overbed Table | 30" | 15 1/2" | 30" Max | 27 lbs. |

Construction Specifications

| | |
|----------------------|---|
| Universal Dimensions | Adjustable heights to fit over OR table or hospital bed |
| Materials | 304 stainless steel Liberty: Telescoping aluminum lifting columns. Overbed Table: Mar resistant laminate (tray), chrome plate steel (column & base) |
| Gauge | Liberty: 16GA Top; 11GA Sub Top; 14GA Base Georgetown: 18GA Top; 16GA Sub Top, 2" 16GA square tube legs |
| Welding | All welding by heliarc method and exposed welds are ground smooth |
| Finish | Exposed surfaces are free from pit marks, weld seams, scale and are polished with #4 polish to a satin finish |
| Casters | Liberty: 4" antistatic swivel casters with brakes Georgetown: 3" swivel casters, two with brakes |
| Notes | Liberty: Motorized adjustment mechanism Electrical Ratings: 100-120VAC, 15AMP, 60 Hz. Georgetown: Manual adjustment mechanism |

Shipping Information

All shipping weights are estimates and may be changed without prior notice. Specifications may be improved and dimensions changed without prior notice. Please contact customer service for estimated shipping costs at info@blickman.com.

Custom Dimensions Available Upon Request
Please email us at info@blickman.com

THE BLICKMAN DIFFERENCE

Stationary Tables

- We offer a variety of stationary tables to fit any healthcare need. Our stationary tables include instrument tables, utility tables, and general work tables. Some models also come in MR conditional equivalents.
- Our instrument tables are reinforced with H-braces for stability or include an optional lower shelf for storing supplies. We offer standard dimensions or that can be customized to any size. We also have an optional nested set of up to six tables that can be ordered together or separately.
- Our utility tables come in a variety of drawer and shelf configurations to store and protect equipment and can include a workspace so you can store and prep your supplies on one efficient and transportable, setup.
- Our work tables are heavy duty with large surface areas designed for use in sterile and non-sterile preparation.

Key Product Features



NESTED TABLES

Description: Our nested instrument tables are space saving alternatives with a unique design that requires a mere 8 square feet of floor space, but yields 31 square feet of usable work space. All tables travel on 3" casters.



| Name | Dimensions (WxHxD) | Model # | Item # | Shipping Weight |
|-------------------|--|---------|------------|-----------------|
| Complete Set of 6 | 8 Sq. Ft. of Floor Space 31 Sq. Ft. of Work Space | 782ISS | 0137821000 | 255 lbs. |

ORDER SEPARATELY

| | | | | |
|----------|-----------------|--------|------------|---------|
| Largest | 48" x 42" x 24" | 7822SS | 0137822000 | 56 lbs. |
| Second | 44" x 40" x 22" | 7823SS | 0137823000 | 52 lbs. |
| Third | 40" x 38" x 20" | 7824SS | 0137824000 | 51 lbs. |
| Fourth | 36" x 36" x 18" | 7825SS | 0137825000 | 37 lbs. |
| Fifth | 32" x 34" x 16" | 7826SS | 0137826000 | 34 lbs. |
| Smallest | 28" x 32" x 14" | 7827SS | 0137827000 | 32 lbs. |

MR Conditional Tables

NESTED TABLES

Description: Our MR conditional nested instrument tables are space saving alternatives with a unique design that requires a mere 8 square feet of floor space, but yields 31 square feet of usable work space. All nested tables travel on 2" MR casters.



| Name | Dimensions (WxHxD) | Model # | Item # | Ship Weight |
|-------------------|--|---------|------------|-------------|
| Complete Set of 6 | 8 Sq. Ft. of Floor Space 31 Sq. Ft. of Work Space | 7821MR | 0197821000 | 255 lbs. |

ORDER SEPARATELY

| | | | | |
|----------|-----------------|--------|------------|---------|
| Largest | 48" x 42" x 24" | 7822MR | 0197822100 | 56 lbs. |
| Second | 44" x 40" x 22" | 7823MR | 0197823100 | 52 lbs. |
| Third | 40" x 38" x 20" | 7824MR | 0197824100 | 51 lbs. |
| Fourth | 36" x 36" x 18" | 7825MR | 0197825100 | 37 lbs. |
| Fifth | 32" x 34" x 16" | 7826MR | 0197826100 | 34 lbs. |
| Smallest | 28" x 32" x 14" | 7827MR | 0197827100 | 32 lbs. |

Tables

Instrument Tables

HOWARD & SAWYER TABLES

Description: Our instrument tables offer complete 18 gauge, 304 stainless steel construction. They are lightweight, yet extremely durable. Sanitary closed top help prevents bacterial build up. Sealed reinforcing channels provide rigidity. All tables are 34" tall, which is in the safety zone for reduced back stress, and travel on 3" casters. There is a 16" clearance between shelves. Our 4 most common sizes are listed below, however we offer a wide variety of other sizes that you can order by calling our customer service or visiting our website.

Sawyer Table



Howard Table



| Table | Sawyer Table | | | Howard Table | | |
|------------------|--------------|------------|----------|--------------|------------|----------|
| Dimensions (WxD) | H-Brace | | | Shelf | | |
| 20" x 16" | 7840SS | 0127840000 | 28 lbs. | 7830SS | 0117830000 | 32 lbs. |
| 30" x 16" | 7839SS | 0127839000 | 33 lbs. | 7829SS | 0117829000 | 40 lbs. |
| 33" x 18" | 7841SS | 0127841000 | 39 lbs. | 7831SS | 0117831000 | 47 lbs. |
| 36" x 20" | 7842SS | 0127842000 | 42 lbs. | 7832SS | 0117832000 | 52 lbs. |
| 36" x 24" | 7843SS | 0127843000 | 48 lbs. | 7833SS | 0117833000 | 56 lbs. |
| 48" x 20" | 7844SS | 0127844000 | 53 lbs. | 7834SS | 0117834000 | 66 lbs. |
| 48" x 24" | 7845SS | 0127845000 | 56 lbs. | 7835SS | 0117835000 | 69 lbs. |
| 60" x 24" | 7846SS | 0127846000 | 178 lbs. | 7836SS | 0117836000 | 190 lbs. |
| 72" x 24" | 7847SS | 0127847000 | 186 lbs. | 7837SS | 0117837000 | 210 lbs. |

Options: Custom dimensions, 40"H tables, three sided guardrails, and drawers (see Crescent table design).

MR Conditional

Tables

INSTRUMENT TABLES

Description: Our MR conditional instrument tables offer complete 18 gauge, 304 stainless steel construction. A sanitary closed top helps prevent bacterial build up. Sealed reinforcing channels provide increased rigidity. All tables are at an ergonomic reinforcing height of 34" tall with 1 ¼" diameter legs that are fully welded for strength and stability. Each MR conditional instrument table travels on 2" MR casters. There is a 16" clearance between shelves. Our 4 most common sizes are listed below, however we offer a wide variety of other sizes which you can order by calling customer service or visiting our website.



| Surface Area | MR Conditional Sawyer Table | MR Conditional Howard Table |
|------------------|-----------------------------|-----------------------------|
| 20" x 16" | | |
| Model # | 7840MR | 7830MR |
| Item # | 0197840100 | 0187830100 |
| Shipping Weight | 28 lbs. | 32 lbs. |
| 36" x 24" | | |
| Model # | 7843MR | 7833MR |
| Item # | 0197843100 | 0187833100 |
| Shipping Weight | 48 lbs. | 56 lbs. |
| 48" x 24" | | |
| Model # | 7845MR | 7835MR |
| Item # | 0197845100 | 0187835100 |
| Shipping Weight | 56 lbs. | 69 lbs. |
| 60" x 24" | | |
| Model # | 7846MR | 7836MR |
| Item # | 0197846100 | 0187836100 |
| Shipping Weight | 189 lbs. | 200 lbs. |

Custom Dimensions Available Upon Request

Please email us at info@blickman.com

ANGULAR INSTRUMENT TABLE

Description: Choose our angular instrument table to have separate left and right work spaces. Add a lower shelf or drawers for additional storage. This 34" tall table is in the safety zone for reduced back stress, and it travels on 3" casters. Select the surface area with dimensions that fit your needs.



| Model # | Item # | Description | Width | Depth | Height | Shipping Weight |
|---------|------------|--------------------------|-------|-------|--------|-----------------|
| 7862SSA | 0147862000 | Angular Instrument Table | 60" | 15" | 34" | 120 lbs. |
| 7863SSA | 0147863000 | Angular Instrument Table | 72" | 18" | 34" | 137 lbs. |

Custom Dimensions Available Upon Request
Please email us at info@blickman.com

Tables

UTILITY TABLES

Description: Our utility tables are popular in the OR as anesthesia tables and throughout healthcare facilities as a general utility table. Our superior construction adds a supporting channel underneath the top shelf to enhance its strength. All of our utility tables are 34" tall, which is in the safety zone for reduced back stress, and travel easily on 3" casters.

Shelf Configuration Includes:

- ✓ Two shelves, 17" and 34" off the ground
- ✓ Four sided guardrails for protection

Drawer Configurations Include:

- ✓ A positive stop to prevent accidental drawer removal
- ✓ Ball bearing slides for easy sliding drawers
- ✓ Three sided guardrails for protection (optional four sided guardrails are available)

All of our utility tables are the same dimensions:

Width: 20" x Height: 34" x Depth: 16"



Lower Shelf Clearance:
16"

Lower Shelf Clearance:
11"

Lower Shelf Clearance:
5 1/2"

Lower Shelf Clearance:
4 1/4"

Lowest Drawer Clearance:
11 1/2"

| # of Drawers | 0 | 1 | 2 | 3 | 4 |
|-----------------|------------|------------|------------|------------|------------|
| Model # | 7852SS | 7850SS | 7754SS | 7857SS | 7859SS |
| Item # | 0257852000 | 0217850000 | 0227754000 | 0237857000 | 0247859000 |
| Shipping Weight | 32 lbs. | 46 lbs. | 59 lbs. | 72 lbs. | 82 lbs. |

Options: Feet: glides, rubber tips, or larger diameter casters, four sided guard rails on drawer models

CRESCENT TABLES

Description: Our crescent table has the same construction as the Howard and Sawyer Instrument tables with the addition of drawers and guard rails. This table includes a large work surface area (36"x 20"), two 4" deep drawers and one optional lower shelf 16" off the ground. This model is 34" tall, which is in the safety zone for reduced back stress, and travels easily on 3" casters.

Customize the surface area dimensions of these models to fit your needs.



| Model # | Item # | Description | Width | Depth | Height | Shipping Weight |
|-----------|------------|--------------------------|-------|-------|--------|-----------------|
| 7856SS | 0317856000 | Crescent Table (H-Brace) | 36" | 20" | 34" | 78 lbs. |
| 7856SS-SH | 0317856003 | Crescent Table (Shelf) | 36" | 20" | 34" | 81 lbs. |

Options: Feet: glides, rubber tips, or larger diameter casters

WORK TABLES

Description: Our work tables are designed for use as prep tables. They are heavy duty with large surface areas designed for use in sterile and non-sterile environments. The smallest table dimensions use four legs, and all other larger dimensions use six legs. All of our work tables are 36" tall, which is in the safety zone for reduced back stress, and come standard with bullet feet. Rubber tips, casters, and gliders are available as alternative options.

Customize the surface area dimensions of these models to fit your needs.



| Model # | Item # | Description | Width | Depth | Height | Shipping Weight |
|----------------|------------|-------------|-------|-------|--------|-----------------|
| H-Brace | | | | | | |
| CSDT6830 | 0336830000 | Work Table | 68" | 30" | 36" | 210 lbs. |
| CSDT8036 | 0338036000 | Work Table | 80" | 36" | 36" | 300 lbs. |
| CSDT9244 | 0339244000 | Work Table | 92" | 44" | 36" | 390 lbs. |
| Shelf | | | | | | |
| CSDT6830S1 | 0336830100 | Work Table | 68" | 30" | 36" | 260 lbs. |
| CSDT8036S1 | 0338036100 | Work Table | 80" | 36" | 36" | 355 lbs. |
| CSDT9244S1 | 0339244100 | Work Table | 92" | 44" | 36" | 435 lbs. |

Options: Feet: glides, rubber tips, or larger diameter casters

Custom Designs Available Upon Request

Please email us at info@blickman.com

STATIONARY TABLE OPTIONS

Drawers

Description: For added storage, add drawers beneath any tabletop.



**contact us for available drawers and sizing*

Guardrails

Description: For added placement security, add guardrails to any tabletop.



Custom Designs Available Upon Request

Please email us at info@blickman.com

Tables

Options

STATIONARY TABLE OPTIONS

Feet Options

Rubber Tips | Casters | Gliders



Custom Designs Available Upon Request
Please email us at info@blickman.com

BLICKMAN



Utility Carts

Convenient transport for medical equipment

Includes:

- Light Duty
- Medium Duty
- Heavy Duty



THE BLICKMAN DIFFERENCE

- Our utility carts are ideal for transporting medical equipment which needs to be used in various areas in your medical facility. We offer light duty, medium duty, and heavy duty options to suit all of your needs.
- Common features include a push handle, open construction for easy access, guardrails for securing contents, and 4" swivel casters for easy maneuverability.
- They contain two or three solid stainless steel shelves to provide ample storage space.
- The stainless steel construction allows for easy cleaning and sanitizing, while resisting corrosion and stains.
- We also offer a folding utility cart with wire baskets for any application such as movement of mail, patient records, and laboratory materials.

Key Product Features



Utility Carts

Light Duty

FOLDING UTILITY CART

Description: Our folding utility cart is versatile enough for any application such as movement of mail, patient records, and laboratory materials. Choose any combination of 6" or 12" deep wire baskets to complete your cart. The metal frame is designed for easy assembly and folds for storage. Rubber stoppers support and protect the wire racks and provide a quiet ride on four, 3" hard rubber casters.

Folding Utility Cart Dimensions:

Width: 29 1/4" x Height: 38 1/2" x Depth: 19 1/2"



6" Wire Basket (2441)

Item #: 2422441000



12" Wire Basket (2442)

Item #: 2422442000

| Name | Model # | Item # | Shipping Weight |
|---------------------------|-------------|------------|-----------------|
| Kit with 6" + 12" Baskets | 2440 KIT | 24224400KT | 33 lbs. |
| Kit with Two 6" Baskets | 2440 6 KIT | 24224401KT | 31 lbs. |
| Kit with Two 12" Baskets | 2440 12 KIT | 24224402KT | 35 lbs. |

ORDER SEPARATELY

| | | | |
|-----------------|------|------------|---------|
| Folding Frame | 2440 | 2422440000 | 21 lbs. |
| 6" Wire Basket | 2441 | 2422441000 | 5 lbs. |
| 12" Wire Basket | 2442 | 2422442000 | 6 lbs. |

Utility Carts

Light Duty

LIGHT DUTY CARTS

Description: Our light duty 7534 utility cart comes standard with three shelves and a push handle. The top two shelves have three sides and an open front to slide in equipment with ease while also securing supplies. The bottom shelf has no sides for easy access to materials. We offer optional designs with additional guardrails and IV poles.

Our light duty carts have the same dimensions:

Width: 28 1/4" x Height: 35 3/4" x Depth: 16"



Top Shelf: Three Sided Shelf with Open Front Edge
Middle Shelf: Three Sided Shelf with Open Front Edge
Bottom Shelf: Open Shelf



Top Shelf: Three Sided Shelf with Open Front Edge
Middle Shelf: Three Sided Shelf with Front Guardrail
Bottom Shelf: Shelf with Four Guardrails



Top Shelf: Three Sided Shelf with Front Guardrail
Middle Shelf: Three Sided Shelf with Front Guardrail
Bottom Shelf: Shelf with Four Guardrails

| Name | Light Duty Utility Cart | Light Duty Utility Cart with 5 Guardrails | Light Duty Utility Cart with 6 Guardrails |
|-----------------|-------------------------|---|---|
| Model # | 7534SS | 7534SS-GR | 7534SS-GR4 |
| Item # | 2427534002 | 2427534000 | 2427534004 |
| Shipping Weight | 30 lbs. | 30 lbs. | 30 lbs. |

Options: IV pole attachments.

Custom Designs Available Upon Request
 Please email us at info@blickman.com

Utility Carts

Medium/Heavy Duty

MEDIUM DUTY CARTS

Description: Our medium duty utility carts each come with three solid stainless steel shelves and travel on 4" swivel casters. Choose between our design that includes four sided shelves and width-wise handles or our design that includes open shelving and depth-wise handles.



Dimensions: 27 1/2" x 40" x 18 1/8"



Dimensions: 25" x 16 1/2" x 35 3/4"

| Name | Side Rails Medium Duty Cart | End Rails Medium Duty Cart |
|-----------------|-----------------------------|----------------------------|
| Model # | 7535SS | 7536SS |
| Item # | 2427535000 | 2427536000 |
| Shipping Weight | 47 lbs. | 40 lbs. |

Options: IV pole attachments.



Dimensions: 41 3/4" x 40" x 19 1/4"

HEAVY DUTY CART

Description: Our heavy duty utility cart comes with two solid stainless steel shelves with four sides each and travels on 5" swivel casters. Easy maneuverability with angled pushhandles.

| Name | Heavy Duty Cart |
|-----------------|-----------------|
| Model # | 7537SS |
| Item # | 2427537000 |
| Shipping Weight | 43 lbs. |

Options: IV pole attachments.

Custom Designs Available Upon Request

Please email us at info@blickman.com

Utility Carts

Accessories

IV POLE ATTACHMENTS

Description: Our IV pole attachment can fit any Blickman utility cart with ease.



| Name | 7534SS with IV pole attachment | 7535SS with IV pole attachment | 7536SS with IV pole attachment | 7537SS with IV pole attachment |
|-----------------|--------------------------------|--------------------------------|--------------------------------|--------------------------------|
| Model # | 7534SS-IV | 7535SS-IV | 7536SS-IV | 7537SS-IV |
| Item # | 2427534001 | 2427535001 | 2427536001 | 2427537001 |
| Shipping Weight | 35 lbs. | 52 lbs. | 45 lbs. | 48 lbs. |

GUARDRAILS & SIDING

Contact Blickman Customer Service about adding additional siding or guardrails.



Open Shelf



Lipped Shelf



Shelf with 4 Guardrails



3 Sided Shelf

Custom Designs Available Upon Request

Please email us at info@blickman.com.

MR Conditional

Utility Carts

UTILITY CARTS

Description: Our MR conditional utility carts are made out of industry standard, fully welded, stainless steel construction. They feature two to three easy-access storage shelves and two ergonomic push handles. Optional IV pole attachments available for every model.



| Name | Medium Duty End Rails Utility Cart | Medium Duty Side Rails Utility Cart | Heavy Duty Utility Cart |
|---|------------------------------------|-------------------------------------|-------------------------|
| MR Conditional Standard Models | | | |
| Item # | 7536SS-MR | 7535SS-MR | 7537SS-MR |
| Model # | 2497536000 | 2497535000 | 2497537000 |
| Shipping Weight | 40 lbs. | 47 lbs. | 43 lbs. |
| MR Conditional Models with IV Attachments | | | |
| Item # | 7536SS-IV-MR | 7535SS-IV-MR | 7537SS-IV-MR |
| Model # | 2497536001 | 2497535001 | 2497537001 |
| Shipping Weight | 45 lbs. | 52 lbs. | 48 lbs. |

Utility Carts

Construction Specifications

Construction Specifications

Universal Dimensions

Light Duty: Width: 28 1/4" x Height: 35 3/4" x Depth: 16"

Materials

Stainless steel
Rubber bumper handles on 7534SS Carts

Gauge

Light Duty: 20GA & 18GA
Medium/Heavy Duty: 16GA

Welding

All welding by spot and heliarc methods and exposed welds are ground smooth

Finish

Exposed surfaces are free from pit marks, weld seams, scale and are polished with a #4 polish to a satin finish

Casters

4" Swivel Casters

Shipping Information

All shipping weights are estimates and may be changed without prior notice. Specifications may be improved and dimensions changed without prior notice. Please contact customer service for estimated shipping costs at info@blickman.com.

Custom Designs Available Upon Request

Please email us at info@blickman.com

BLICKMAN



Warming Cabinets

Keeping patients warm and comfortable

Includes:

- Freestanding
- Under Counter
- Recessed
- Accessories
- Tabletop



THE BLICKMAN DIFFERENCE

- We maintain the broadest line of warming cabinets in the healthcare market. Our blanket and fluid warming cabinets include freestanding, single chamber, dual chamber, tabletop, under-counter, and recessed models (including pass-through versions with doors on front and back).
- All of our models are offered with the choice of glass or stainless steel doors at the same price. Our glass door versions have wide windows designed to allow medical professionals to see all solutions and blankets at a glance, unlike the narrower porthole openings in competing models, so you never come up short of supplies in critical moments.
- Our warming cabinets allow for heat variances between 90° and 160° Fahrenheit. Temperatures remain within +/- 1° Fahrenheit of set point with virtually no leakage into adjoining chambers or outside area.
- The warming fan is located at the top interior of the cabinet allowing for improved heat circulation (no hot/cold spots) and frees up the bottom shelf surface to store more blankets and/or solutions.
- Our touch screen and digital control panels allow O.R. managers to lock the warming cabinet settings with a key or passcode to ensure recommended temperature levels are maintained and that the facility meets all requirements.
- Unlike with cumbersome, “meat locker” handles on competing models, our warming cabinets allow for hands free operation. Our warming cabinets comes standard with self-closing, adjustable tension, magnetic gasket doors. If your arms are full, simply open the door with your elbow and then the door will slowly close on its own.

www.blickman.com

Key Product Features

Sloped top available for freestanding models to prevent dust collection

Dual chamber models enable you to heat solutions and blankets simultaneously in their respective recommended temperatures

Wide glass window designed to let medical professionals see all solutions and blankets at a glance

Free standing and recessed options available for tall models



Touch Screen Control Panel



Digital Screen Control Panel



Universal Controller Features:

- Visual/audible alarm
- Digital adjustments
- Calibration due date reminder
- Graphical temp. trend view
- Set temp. "lock out"
- Lost passcode view
- Temp. data recorder w/ real time clock

Self-closing, magnetic gasket, adjustable tension doors afford convenient, hands free opening and closing

Warming Cabinets

Freestanding

Description: Our freestanding cabinets come in either single or dual chamber configurations with open adjustable shelf design for flexibility and expanded use. The doors come in either glass or stainless steel and lock to secure contents. Each unit comes standard with three perforated stainless steel shelves and integrated casters for ease of mobility.

Dimensions

Width: 30" x Height: 74 1/2" x Depth: 26 5/8"



Electrical: Amps: 7.5 | Total Wattage: 750

Electrical: Amps: 15 | Total Wattage: 1500

| Name | Single Chamber | | Dual Chamber | |
|-----------------|--------------------|----------------|--------------|----------------|
| | Glass Doors | | | |
| Controller Type | Touch Screen | Digital Screen | Touch Screen | Digital Screen |
| Model # | 8921TG | 7921TG | 8924TG | 7924TG |
| Item # Shipping | 14B8921243 | 14B7921243 | 14B8924243 | 14B7924243 |
| Weight | 437 lbs. | 437 lbs. | 500 lbs. | 500 lbs. |
| | Solid Doors | | | |
| Controller Type | Touch Screen | Digital Screen | Touch Screen | Digital Screen |
| Model # | 8921TS | 7921TS | 8924TS | 7924TS |
| Item # Shipping | 14B8921200 | 14B7921200 | 14B8924200 | 14B7924200 |
| Weight | 437 lbs. | 437 lbs. | 500 lbs. | 500 lbs. |

Options: No Casters, sloped tops

Warming Cabinets

Recessed

Description: Our recessed warming cabinets are designed for built-in installation. Single chamber glass door, solid door, and passthrough models available. Three perforated stainless steel shelves come standard in these models.

Dimensions

Width: 30" x Height: 60" x Depth: 20 5/8"

Electrical: Amps: 7.5 | Total Wattage: 750

Glass Door



Solid Door



Passthrough



| Name | Glass Door | | Solid Door | | Passthrough | |
|-----------------|--------------|----------------|--------------|----------------|--------------|----------------|
| Controller Type | Touch Screen | Digital Screen | Touch Screen | Digital Screen | Touch Screen | Digital Screen |
| Model # | SW40TG | SW30TG | SW40TS | SW30TS | SW40TPTGS | SW30TPTGS |
| Item # Shipping | 14BSW40243 | 14BSW30243 | 14BSW40200 | 14BSW30200 | 14BSW40278 | 14BSW30278 |
| Weight | 320 lbs. | 320 lbs. | 320 lbs. | 320 lbs. | 245 lbs. | 245 lbs. |

Options: Dual chambers, additional shelves.

Note: Passthrough models are available in the following configurations: glass/glass, solid/solid, glass/solid, or solid/glass.

Warming Cabinets

Under Counter

Description: Our under counter warming cabinet is suited for use in limited spaces. It comes with either glass or stainless steel doors, and comes standard with two adjustable perforated stainless steel shelves.

Dimensions

Width: 30" x Height: 35 1/2" x Depth: 26 5/8"

Electrical: Amps: 7.5 | Total Wattage: 750



Name

Single Chamber

| | Glass Door | | Solid Door | |
|-----------------|--------------|----------------|--------------|----------------|
| Controller Type | Touch Screen | Digital Screen | Touch Screen | Digital Screen |
| Model # | 8922TG | 7922TG | 8922TS | 7922TS |
| Item # Shipping | 14B8922243 | 14B7922243 | 14B8922200 | 14B7922200 |
| Weight | 260 lbs. | 260 lbs. | 260 lbs. | 260 lbs. |

Options: Sloped tops

Warming Cabinets

Tabletop

Description: Our tabletop warming cabinets are available in a standard and compact size. They can sit on an existing countertop or on a Blickman mobile stand specifically designed to support our tabletop warmers. They come with either glass or stainless steel doors. One adjustable perforated stainless steel shelf is included in the standard model only.

Dimensions: 30" x 24 1/2" x 26 5/8"
Electrical: Amps: 7.5 | Total Wattage: 750



Dimensions: 24" x 24 1/2" x 20 5/8"
Electrical: Amps: 3.5 | Total Wattage: 350



| Name | Standard | | Compact | |
|-----------------|--------------------|----------------|--------------|----------------|
| | Glass Doors | | | |
| Controller Type | Touch Screen | Digital Screen | Touch Screen | Digital Screen |
| Model # | 8925TG | 7925TG | 8927TG | 7927TG |
| Item # Shipping | 14B8925243 | 14B7925243 | 14B8927243 | 14B7927243 |
| Weight | 215 lbs. | 215 lbs. | 161 lbs. | 161 lbs. |
| | Solid Doors | | | |
| Controller Type | Touch Screen | Digital Screen | Touch Screen | Digital Screen |
| Model # | 8925TS | 7925TS | 8927TS | 7927TS |
| Item # Shipping | 14B8925200 | 14B7925200 | 14B8927200 | 14B7927200 |
| Weight | 215 lbs. | 215 lbs. | 161 lbs. | 161 lbs. |

To set up a solutions only warming cabinet, these units can easily be programmed by the user to heat only between 90°F and 110°F. Options: Sloped tops for 925 models.

Warming Cabinets

Tabletop Mobile Stand



Description: Our warming cabinet mobile stand allows for our tabletop warming cabinets to become mobilized for transport around your medical facility. These tables are designed to fit both our standard or compact tabletop warming cabinet dimensions without taking up any extra floor space. It includes three sides to secure warming cabinet placement and an optional shelf with four guardrails is available for additional storage.



Cleat in the back to coil power cord during transport.

For transportation, wrap warming cabinet cable around cleat on the back of the mobile stand.

Table Dimensions

Width: 30" x Height: 34" x Depth: 26"



| Name | H-Brace | Shelf |
|-----------------|------------|------------|
| Model # | 3026SSH | 3026SS |
| Item # | 0123026100 | 0113026000 |
| Shipping Weight | 40 lbs. | 50 lbs. |



Warming Cabinets

Accessories & Power Consumption

ACCESSORIES



| Item | Description | Shipping Weight |
|------------|--|-----------------|
| 14B3018000 | Sloped top (30" x 8" x 18") for warming cabinet SW40 | 28 lbs. |
| 14B3026000 | Sloped top (29 7/8" x 10" x 26") for warming cabinets: 8921, 8922, 8924, 8925 | 38 lbs. |



| Item | Description | Shipping Weight |
|------------|--|-----------------|
| 14B8924SHF | Warming Cabinet Shelf Kit 30" x 26" with 1" Diameter holes for 8921, 8922, 8924, 8925 | 78 lbs. |
| 14B8927SHF | Warming Cabinet Shelf Kit 20" x 17 1/2" for 8927 | 28 lbs. |
| 14BSW40SHF | Warming Cabinet Shelf Kit 30" x 18" for SW40 | 38 lbs. |

POWER CONSUMPTION

| Model # | Description | Cubic Feet | KW/Hr. | BTU/Hr. |
|---------|-------------------------------------|------------|--------|---------|
| 8921 | Single Chamber Tall Warming Cabinet | 22.02 | 0.55 | 1878 |
| 8922 | Under Counter Warming Cabinet | 9.02 | 0.35 | 1195 |
| 8924 | Dual Chamber Tall Warming Cabinet | 18.58 | 0.78 | 2664 |
| 8925 | Standard Tabletop Warming Cabinet | 5.05 | 0.29 | 990 |
| 8927 | Compact Tabletop Warming Cabinet | 2.87 | 0.38 | 1298 |
| SW40 | Recessed Warming Cabinet | 13.22 | 0.47 | 1605 |

Warming Cabinets

Construction Specifications

Construction Specifications

| | |
|---------------------|--|
| Standard Dimensions | Free Standing: 30" x 74 1/2" x 26 5/8" Recessed: 30" x 60" x 20 5/8" Table Top: Standard: 30" x 26 5/8" x 24 1/2"; Compact: 24" x 20 5/8" x 24 1/2" Under Counter: 30" x 60" x 20 5/8" |
| Materials/ Gauge | 304 stainless steel 1/4" clear double panel, insulated, tempered sheet glass Perforated Stainless Steel Shelves |
| Welding | All welding by heliarc method and exposed welds are ground smooth |
| Finish | Exposed surfaces are free from pit marks, weld seams, scale and are polished with #4 polish to a satin finish |
| Electrical | Available in standard 100/120 VAC input or 220/240 VAC Units are FDA registered and conform to standards for Safety Medical Electrical Equipment UL 60601I (US) and CSA C22.2 #601.1M90 (Canada) Units are cord connected with a hospital grade cap |
| Casters | Tall Warming Cabinets: Hidden 3" ball bearing polyolefin casters with zinc finish |
| Notes | <ul style="list-style-type: none">• TOUCHSCREEN CONTROLLER: LCD display shows actual temperature and set point for each chamber at all times. Control panel components include an On/Off Switch, Keyed Control Temperature Lockout USB port and Touchscreen User Interface.• DIGITAL CONTROLLER: Dual display shows actual temperature and set point for each chamber at all times (each chamber in the double door warmer includes its own digital control system). Control panel components include an ON/OFF Button, UP/DOWN Temperature Touch pad, Alarm Light, Heater Light Indicator, Set/Mute Touch• TEMPERATURE: 90° to 160° Fahrenheit. There is a heater light indicator, digital temperature indicators and an over temperature alarm indicator if the actual temperature exceeds set temperature by 10° Fahrenheit. All units have a visual and audible alarm as well as an automatic safety switch. The units are furnished with tubular heater assemblies and a circulating fan for even heat distribution. From a cold start, a fully loaded cabinet will be heated to the selected temperature in four to six hours. |

Shipping Information

All shipping weights are estimates and may be changed without prior notice. Specifications may be improved and dimensions changed without prior notice. Please contact customer service for estimated shipping costs at info@blickman.com.

Contact Us

To place an order or request a quote, go to our website:

<https://www.blickman.com/order-form>

<https://www.blickman.com/request-a-quote-form>

If you have any questions or would like to speak with our customer service department:

Toll Free: (800) 247-5070

Phone: (973) 330-0557

Email: info@blickman.com

Website: www.blickman.com

If you require tech support, please visit our website at www.blickman.com/tech-support or email us directly at techsupport@blickman.com.

OUR PROMISE

For over 125 years, Blickman has been known throughout the healthcare industry for exceptional product quality. We pride ourselves on providing high-end and personalized service to ensure 100% customer satisfaction. If you are not completely satisfied for any reason, we will make it right. All of our equipment is backed by our Limited Lifetime Warranty, so you can be certain that you have made the very best choice for your healthcare facility.



Explore all we have to offer
www.blickman.com



Corporate Office & Headquarters

1099 Wall Street West
Suite 250
Lyndhurst, NJ
07071